

FEATURE HIGHLIGHTS

- 8 10/100/1000 BASE-T(X) ports, M12 connector
- 2 1000 Base-X SFP slots
- Up to 4 or 8 802.3af or 802.3at compliant PoE ports
- EN50155, EN50121-4 and UL 61010-2-201 certified
- Redundant power input, DC or High Voltage DC
- Ruggedized IP67 aluminum enclosure
- Works from -40°C~75°C
- 2x Relay outputs, 5-pin M12 A-Coding
- Profinet Conformance Class B compatible
- Ethernet/IP Compatible

PRODUCT DESCRIPTION

Atop's EMG8510 IP67-rated Railway-compliant Ethernet switch is the best solution for providing high-speed Gigabit connectivity in bayside or carriage side Railway applications. Its rugged, aluminum enclosure can effectively protect the Switch core in any environment.

The 8-M12 Connectors Gigabit ports can supply up to 30W of PoE Power (802.3af or 802.3at) to your PoE device providing an overall maximum budget of 240W. This makes EMG8508 the ideal solution for on-board or off-board surveillance by simplifying the wiring where it's difficult, risky and expensive to introduce new elements.

Two Gigabit SFP slots provide to EMG8510 Series the capability to be connected with Fiber-Optics to the backbone without the need of Copper Ethernet repeaters and without any risk of signal degradation

The embedded redundant-power supply input provides a reliable and failure-proof safety mechanism to minimize down-times. EMG8510 comes in either redundant Low-Voltage DC power input (12~57 VDC, 47~57 VDC for PoE models) or in redundant High-Voltage DC power input (50~145 VDC). Each power module, including a Relay-output alarm, uses a S-coding M12 connector that makes EMG8508 ideal and simple for engineers setting up a Fault-Alarm System.

Its IP67 housing protection, combined with a wide operating temperature of -40 to 75°C and wall mounting capacities make it suitable to most Railway applications in harsh environments or industrial filed applications

SPECIFICATIONS

Technical Specifications	
Model Name	EMG8510
Switch Properties	
Priority Queues	8
VLAN Table	4096
MAC-Based VLAN	512
VLAN ID Range	VID 1 to 4094
Trunk Group	4
Static IGMP Groups	128
Dynamic IGMP Groups	256
MAC Table Size	16k
Packet Buffer Size	1.5 MB
Jumbo Frame	9216 Byte
Ethernet	
Standards	IEEE 802.3 for 10BaseT IEEE 802.3u for 100BaseT(X) IEEE 802.3ab for 1000BaseT(X) IEEE 802.3z for 1000Base-X IEEE 802.3af / 802.3at for Power over Ethernet IEEE 802.3x for Flow Control, back pressure flow control IEEE 802.1d-2004 for Spanning Tree Protocol IEEE 802.1w for Rapid Spanning Tree Protocol IEEE 802.1s for Multiple Spanning Tree Protocol IEEE 802.1Q for VLAN Tagging IEEE 802.1p for Class of Service IEEE 802.1X for Authentication IEEE 802.3ad for Port Trunk with LACP IEEE 802.3az for Energy Efficient Ethernet
Protocols	IPv4, IPv6, IGMPv1/v2/v3, IGMP Snooping, GARP, GMRP, GVRP, SNMPv1/v2c/v3, SNMP Inform, ICMP, Telnet, SSH, DHCP Server/Relay/Client, DHCP Option 66/67/82, BootP, RARP, TFTP, NTP Server/Client, SNMP, SMTP, SMTP (Gmail), RMON, HTTP, HTTPS, Syslog, MRP (Client), LLDP, IEEE 1588 PTP V1/V2, IEEE 1588 Hardware End-to-End Transparent Clock, 802.1x, EAP, RADIUS, TACACS+, Mirror port, QoS, ACL, Serial Console, U-Ring, ITU-T G.8032 ERPS Ring, STP, RSTP, MSTP, Compatible Ring
Automation Profiles	Profinet CC-B compatible, Ethernet/IP, Modbus/TCP (dedicated registers)
SNMP MIB	MIB II, IF-MIB, SNMPv2 MIB, BRIDGE-MIB, RMON MIB Group 1,2,3,9, RFC RFC 1157, RFC 1213, RFC 1215, RFC 1493, RFC 1643, RFC 1757, RFC 2011, RFC 2012, RFC 2013, RFC 2233, RFC 2571, RFC 2742, RFC 2819, RFC 2863, RFC 3411, RFC 3412, RFC 3413, RFC 3414, RFC 3415, RFC 2674
Power	
Input Voltage	50~145 VDC for High voltage product 12~57 VDC for Non-PoE models 45~57 VDC for 802.3af mode / 51~57 VDC for 802.3at mode
Input Current/Power (System)	50 – 145 VDC, 0.27A max. , 13.5W (For High voltage Models) 12 – 57 VAC, 1.19A max. , 14.28W (For Non-PoE Models)
Input Current (with PoE, full loading)	45 – 57 VDC, 3.08A max. , 138.6W (PoE 802.3af Mode, 8-ports) 51 – 57 VDC, 5.03A max. , 256.53W (PoE 802.3at Mode, 8-ports)
Power input	2 x S-Coding M12 connectors (4 Pin)

Reverse Polarity Protection	Yes
Interfaces	
LED Indicators	PWR1, PWR2, Alarm, Ethernet Act/Link, SFP Link, PoE, Ring
Ethernet Ports	8 10/100/1000BASE-T(X) auto negotiation speed –M12 connector
Console	RS232 (A-coding M12 connector)
Relay Output	2 relay outputs with current carrying capacity of 1A @ 24 VDC (through A-coding M12 connector)
Fiber Optics Ports	Two 1000BASE-X SFP slots
Physical Characteristics	
Housing	IP67 protection according to EN 60529
Dimension (W x H x D) (mm)	216 x 232 x 72
Weight	2kg
Installation	Wall-mount (Optional Din-Rail Kit)
Environmental limits	
Operating Temperature	-40°C~75°C (-40°F~167°F)
Storage Temperature	-40°C~85°C (-40°F~185°F)
Ambient Relative Humidity	5%~95%, 55°C (Non-condensing)

*802.3af PoE output starts from 43 VDC input and 802.3at output starts from 51 VDC input.

DIMENSIONS & LAYOUT

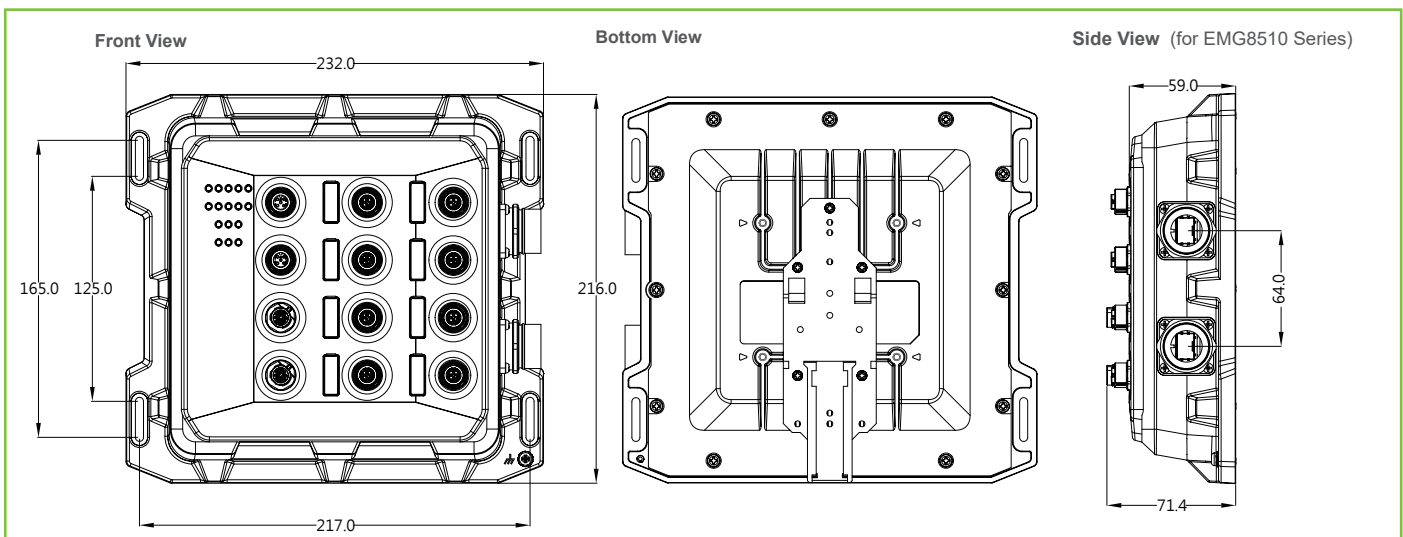

REGULATORY APPROVALS

Regulatory Approvals				
Safety	EN 60950-1:2006, UL/IEC(CB) 61010-2-201			
EMC	FCC Part 15, Subpart B, Class A EN 55032, EN 55024, EN 61000-3-2, EN 61000-3-3, EN 61000-6-2, EN 61000-6-4,			
Rail Traffic	EN50155, EN50121-4			
Test	Item		Value	Level
IEC 61000-4-2	ESD	Contact Discharge	±8KV	4
		Air Discharge	±15KV	4
IEC 61000-4-3	RS	Enclosure Port	10(V/m), 80-1000MHz	3
IEC 61000-4-4	EFT	AC Power Port	±2.0KV	3
		DC Power Port	±2.0KV	3
		Signal Port	±2.0KV	4
IEC 61000-4-5	Surge	AC Power Port	Line-to Line±1.0KV	3
		AC Power Port	Line-to Earth±2.0KV	3
		DC Power Port	Line-to Line±1.0KV	3
		DC Power Port	Line-to Earth±2.0KV	3
		Signal Port	Line-to Earth±2.0KV	3
IEC 61000-4-6	CS	0.15-80MHz	10V rms	3
IEC 61000-4-8	PFMF	(Enclosure)	AC 50Hz 10A/m	3
IEC 61000-4-11	DIP	AC Power Port	-	-
Shock	MIL-STD-810G Method 516.5			
Drop	MIL-STD-810F Method 516.5			
Vibration	MIL-STD-810F Method 514.5 C-1 & C-2			
RoHS	Yes			
MTBF	18.53 years (mean avg. per model; MIL-HDBK-217F-based prediction)			
Warranty	5 years			

ORDERING INFORMATION

Ordering information

Model name	Part Number	M12 Ports	SFP Slots	PoE Ports
EMG8510-2SFP	1P1EMG85100001G	8	2	-
EMG8510-4PoE-2SFP	1P1EMG85100002G	8	2	4
EMG8510-8PoE-2SFP	1P1EMG85100003G	8	2	8
EMG8510-2SFP-HV	1P1EMG85100004G	8	2	-

Optional Accessories

Model name	Part Number	Description
DIN-Rail Kit	70100000000062G	DIN Rail accessories with screw
VESA Kit	70100000000063G	VESA accessories with screw
SDR-75-24	50500752240001G	DIN RAIL POWER SUPPLY / T;AC 88~264V to 24VDC 3.2A;75W
SDR-240-48	50502401480001G	DIN RAIL POWER SUPPLY / T;AC 100~240V to 48V~55V DC 5A;240W
SDR-480-48	50504801480001G	DIN RAIL POWER SUPPLY / T;AC 100~240V to 48V~55V DC 10A;480W
M12 Sealing Cap (Plast)	3990079G	Plastic sealing cap for unoccupied M12 plugs (1560251)
M12 Sealing Cap (metal)	59908571G	Metal sealing cap for unoccupied M12 plugs (1430488)
M12 screw plug (Plast)	3990078G	Plastic Screw Locking for unoccupied M12 sockets (1553129)
M12 screw plug(metal)	59908561G	Metal Screw Locking for unoccupied M12 sockets (1503302)
AFBR-5715ALZ	50710361G	SFP Transceiver for EMG8510, 1250Mbps, 850nm, Muti-mode, 10km, 3.3V, -40~85°C with DMI
AFCT-5715ALZ	50710351G	SFP Transceiver for EMG8510, 1250Mbps, 1310nm, Single-mode, 10km, 3.3V, -40~85°C with DMI