



SOLUTIONS FOR THE SMART GRID

Whitepaper

Engineered and
manufactured
in Taiwan



Contents

04

Welcome to Smart Grid

- 04 Smart Grid
- 06 Power Grid evolution
- 07 Supporting the evolution

14

IEC 61850

- 14 IEC61850, the new standard
- 16 Power Substation Ethernet Switches
- 17 HSR/PRP High Availability Application

20

Legacy networks

- 20 Substation retrofitting
- 21 Supported Protocols
- 22 Success stories

08

The challenges of Smart Grid

- 08 Harsh environments
- 08 Reliability
- 10 Electromagnetic compatibility
- 10 Security and safety
- 12 Fast responsiveness

18

Time Synchronization

- 18 Overview
- 18 IEEE1588v2 Precision Time Protocol
- 19 PTP Elements
- 19 Products

24

Modbus products

- 24 Overview
- 25 Concentrator function
- 25 Redundancy function
- 26 Success stories



Smart grid

The electrical power grid is one of the largest network infrastructures over the surface of the earth. An electrical power system network comprises several components such as power plants, transmission grid, substations, distribution grid, and consumers. Nowadays, the power grid in each continent consists of large, complex networks of high, medium and, low voltage powerlines interconnected to each other. Today, thousands of power plants deliver energy through a complex system, called the power grid to billions of consumers whose life depends on the availability of electrical power. The electricity is one of the essential utilities of daily life.

However, the traditional power grid has been constructed and expanded more than a century ago to deliver electricity to the end users. The oldest components in the power grid system could be very old and most of their basic building blocks and concepts have not been changed much with the changing times.

Over the years, due to favourable public policies, economic imperative and technological innovations, the power plants have gone through considerable technological advances, while the transmission lines got connected more than ever. **The power grid, which once could reach only a very small portion of the world's population, now with time has dramatically extended its network and is distributing electricity to a very large population in each continent.** In the 21st century, the traditional power grid system and its operators encounter several difficulties in managing the large system such as aging equipment, higher maintenance cost, higher voltage equipment, obsolete system layout, outdated engineering tools, energy inefficiency, and pressure due to lack of industry regulations.



TRANSMISSION GRID

SCADA

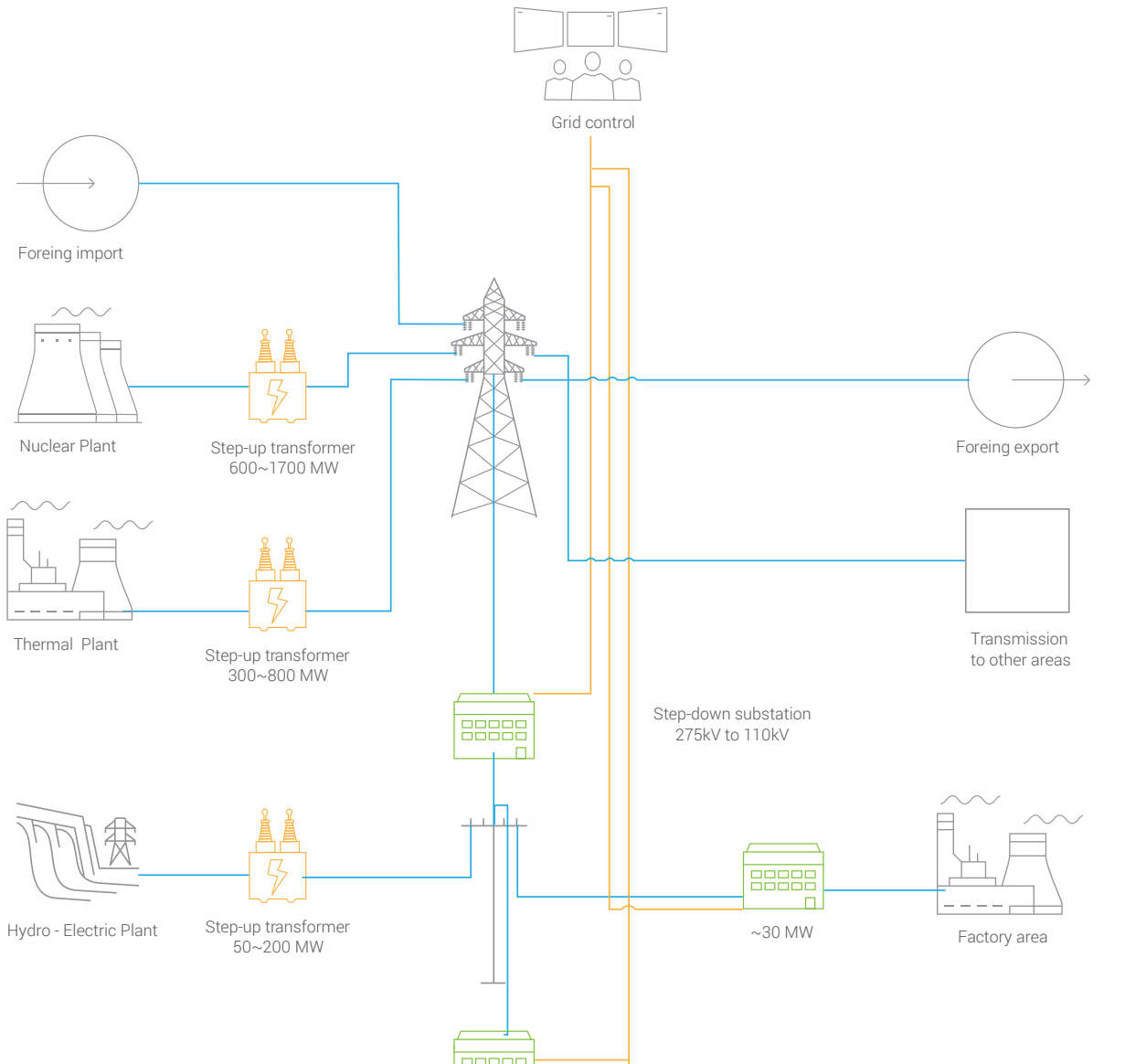

DISTRIBUTION GRID

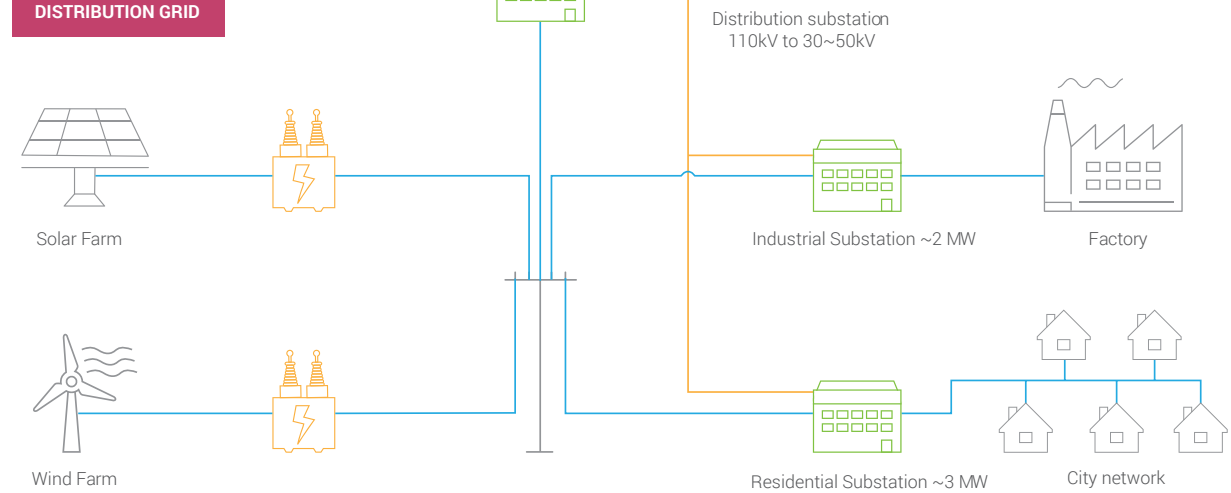

Power Grid evolution

The emerging trend of **green and renewal energy**, such as solar photovoltaic (PV) power system and wind power, introduces several thousands of small power producers into the power grid system. The power system advances toward the goal of supplying reliable electricity from increasingly clean and inexpensive resources. However, since energy generated from these new renewable sources is not constant, it is difficult to manage consistently. To manage multiple grids with increasing number of intermittent energy sources, smarter automation and IT systems are imperative. Additionally, there were new opportunities in the form of two-way flows of electricity and information between the incumbent producers and consumers. While the existing power grid remote supervision was in place long time ago, it cannot cope with this fast-growing trend and massive information flow of data. Fortunately, the Internet revolution, over the past 25 years, has transformed the way people communicate, can be utilized and overlay to enhance the power grid.

A smart grid is an electrical grid with automation, communication and IT systems to monitor power flows from points of generation to points of consumption. The vision of "smart grid", incorporates the modern information technologies into the electrical power grid. It maximizes energy usage and improves the utilization of resources in the grid system. If the traditional grid was made secure only through over-engineering, a smart grid is cost-effective, nimble, responsive, and better engineered for reliability and self-healing operations.

The smart grid is an automated and distributed advanced energy delivery network that can bring more reliability, visibility, predictability, control of generation and continuity of service. The electricity generation industries will be able to reduce grid maintenance activities or down time and brownout with the new technique such as automated demand response program through the smart grid and the introduction of smart meters.

Supporting the evolution

ATOP has been in the thick of smart grid revolution from the very beginning. Whether it is a substation in China or a power plant in Indonesia, ATOP's networking and computing solutions for power industry have enabled the power grids to provide a reliable, safe, and trouble-free service to the energy consumers. This is supported by our experience of two and half decades in industrial automation and our commitment to high investment in research and development from our corporate budget.

ATOP as a leading provider in the domain provides reliable, rugged, and trustworthy backbone for the vision of smart grid with a broad range of information technology products such as precision time distribution, IEC 61850-3 fully-compliance products, network protocol gateways, data concentrators, and industrial managed switches.

Our experienced team can support the customers toward the smart grid (r)evolution - one step at a time in deploying their required design of the most suitable network topology for their specific applications. They are always ready to train and support the users on-site during all steps in their project implementation.

And this is just the beginning...

Want to learn more?

- To know more about our Protocol gateways and Modbus products, check out ATOP **Protocol Product Selection Guide** brochure or datasheet
- To know more about our switches and networking equipment for the power station, check out ATOP **Industrial Networking** brochure, **Switch Product Selection Guide** or datasheet.
- To know more about our Time Distribution, Grandmaster Clock and Precision Time Protocol, check out **Precision Timing Whitepaper**.

Harsh environments

Having a solar power plant in the desert or a substation in Siberia? No problem. **ATOP's rugged products are specifically designed to withstand the harshest environment with wide temperature window on the surface of the planet. .**

Equipped with fanless design and industrial grade components, our products can support applications almost everywhere on the globe and at the same time guarantee a long MTBF by having no moving parts that usually are trigger earlier breakdowns.

Reliability

How much is the acceptable power grid outage down-time nowadays? The answer is zero. With the advent of smart grid, the era of brownouts or blackouts should ideally be rested to history. We should achieve high availability of the system for uninterrupted power supply. Unfortunately, these events can still happen in the complex network with various high voltage and low voltage devices such as the power grid, but they should be minimized as much as possible. Deploying high quality long mean-time-between-failure (MTBF) devices can help minimizing the risk, but the failure can still happen due to either unexpected internal or external causes. ATOP's devices provide redundancy features to further minimize the risk of down-time. In an event of link or device failure, **ATOP's Smart Redundancy Feature will detect the failure, relay back the reason of the failure to a control center, and automatically recover from such failure to provide continuous operation.**

For instance, with High-Availability Technologies such as HSR/PRP, Ethernet Ring Protection Switching (ERPS), RSTP, and Media Redundancy Protocol (MRP) Client settings, network connectivity will be resumed in less than a heartbeat with no hassle.



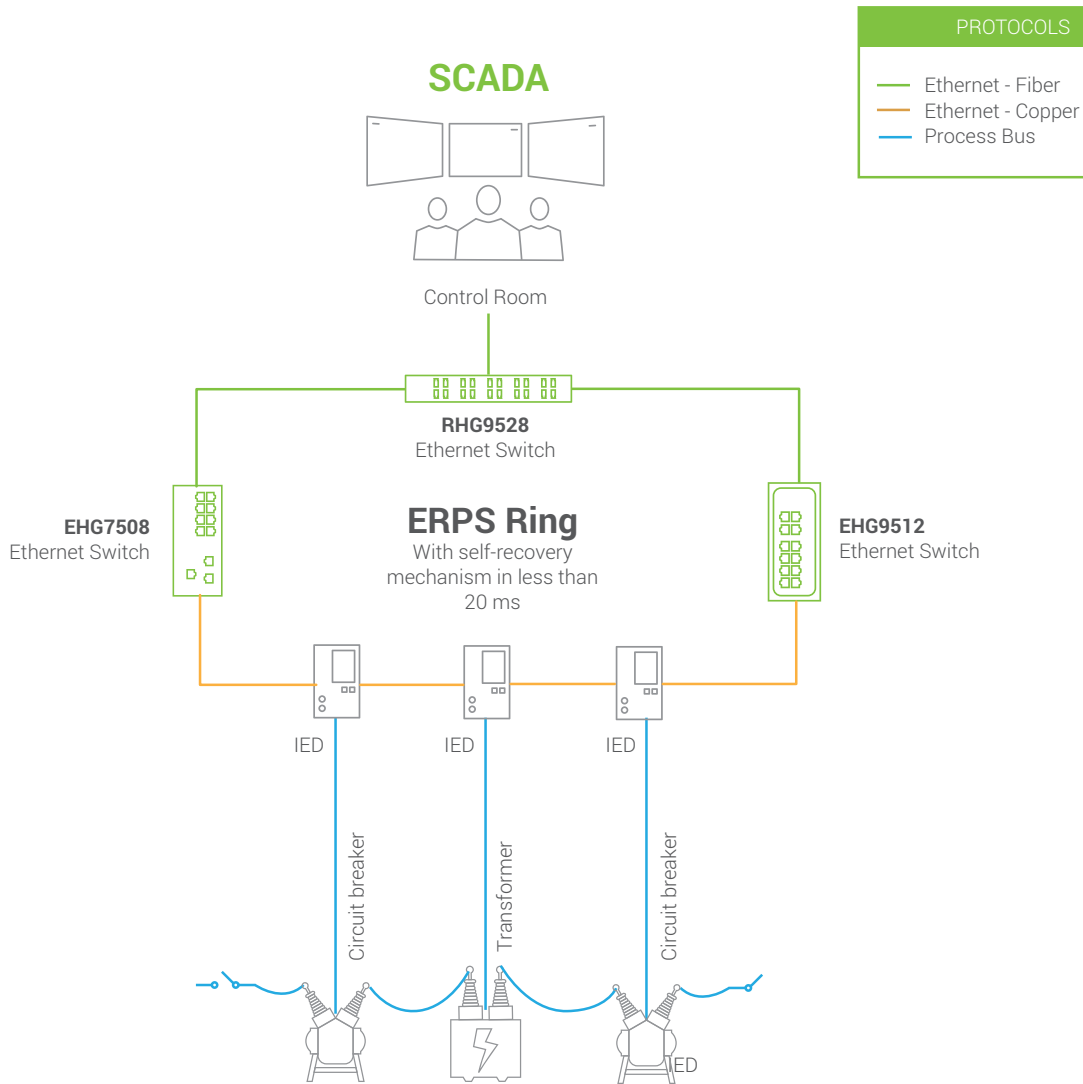



PROTOCOLS

- Ethernet - Fiber
- Ethernet - Copper
- Process Bus

FEATURED PRODUCTS

EHG7508 : Industrial 8-Port PoE Managed Gigabit Switch (-20~70 °C)

- 8 10/100/1000 RJ45 ports or 1000 SFP slots
- maximum 8 x 30 W PoE ports (240W power budget)
- Profinet CC-B v2.33 Certified; Ethernet/IP; ERPS, RSTP, STP, MRP Client redundancy;
- IEEE 1588v2 Hardware-assisted End-to-End TC and many others

EHG9512 : IEC 61850-3 12-Port Managed Gigabit Switch (-40~85 °C)

- 8 x 10/100/1000 RJ45 ports and 4 x 1000 SFP uplink slots
- IEC 61850-3, IEEE 1613 certified
- UL/cUL/IEC(CB) 61010-2-201 certified
- IEEE 1588v2 Hardware-assisted End-to-End TC; ERPS, RSTP, STP, MRP Client redundancy;

RHG9528 : IEC 61850-3 modular Managed Switch, max 24 Gigabit and 4 x 10 GbE ports (-40~85 °C)

- 3 x 8-port Gigabit module slots and 4x 1 or 10 Gigabit SFP uplink slots
- Available modules: 8 x 10/100/1000 RJ45, 8 x 100/1000 SFP, 4 x Gigabit RJ45 or SFP with HSR/PRP
- IEC 61850-3, IEEE 1613, UL/cUL/IEC(CB) 61010-2-201 certified
- IEEE 1588v2 Hardware-assisted Boundary and Transparent Clock. ERPS, RSTP, STP, HSR/PRP redundancy

Electromagnetic compatibility

Electromagnetic Compatibility (EMC) ensures that all electrical and electronic devices function reliably in their intended environments. This compatibility maintains reliability and quality performance, reduces interference to other devices, and enhances safety. Take for example, overhead 230kV power lines or a 13,000 V surge entering the power supply input can be fatal if the deployed devices are not properly shielded and isolated against electromagnetic susceptibility (EMS). Without proper design and precaution against EMS, equipment breakdown could happen.

ATOP's IEC 61850-3 compliant devices are specifically designed to withstand the harshest electromagnetic interferences without suffering fatal damage. ATOP's devices pass EMC level 3 and 4 requirements. They are compliant with the strictest of susceptibility and interference regulations.



Security and safety

Utilities' security and safety are critical in the smart grid era. The more the utilities are remotely controlled over networks, the more they become vulnerable to various threats and malicious activities such as network penetration, taking control of the system, and disruption of the service from industrial espionage, disgruntled employees and terrorists.

Power substations are usually isolated systems, but at ATOP we do see a trend to interconnect remote areas through the internet. ATOP's Protocol Gateway devices provide embedded security measure through virtual private network (VPN) using IP security (IPSec), OpenVPN or PPTP so that all in and out of the device information can be properly protected from potential attacks.

SECURITY

ATOP embedded Modbus and Protocol Gateways seamlessly support your remote application by providing connectivity, security and reliability. Security is provided through Encrypted VPN tunnels

SCADA

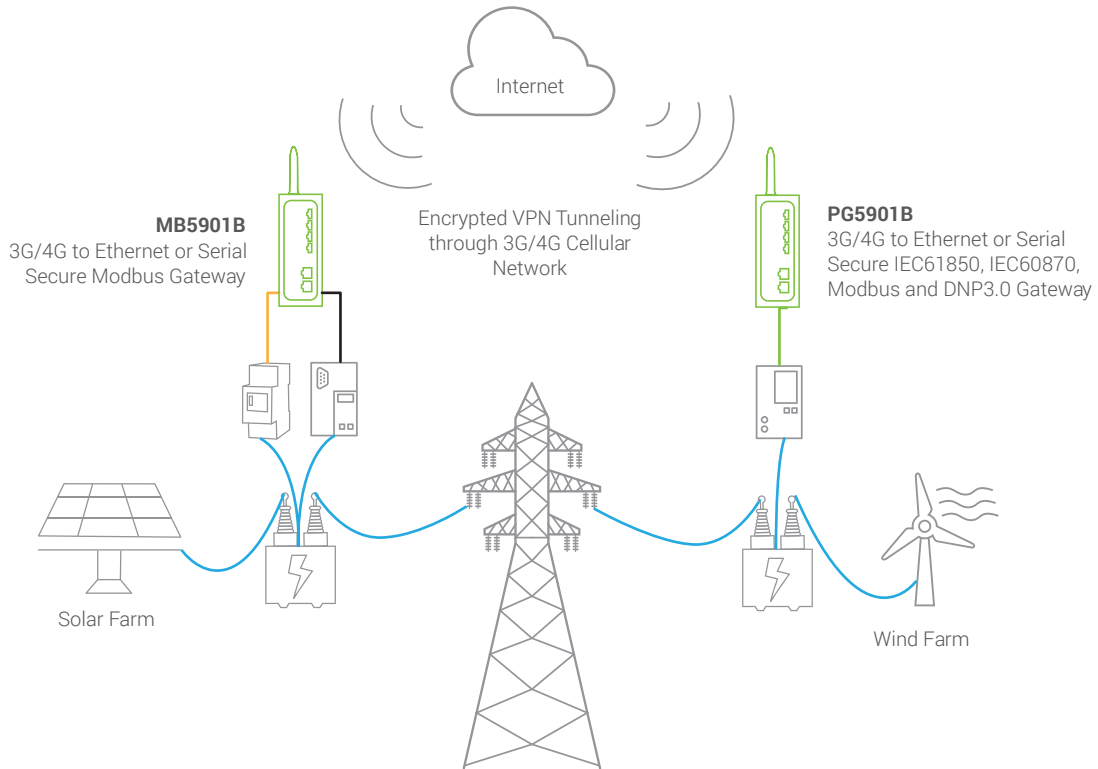
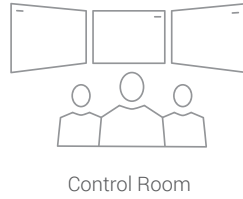

FEATURED PRODUCTS



SE5901B All-in-one 3G/4G to Ethernet or Serial Gateway (-40~75 °C)

- 1 Gigabit RJ45 port, 1 software selectable RS-232 RS-485 RS-422 serial port (2 in I/O version)
- 3G/4G or 4G with integrated GPS cellular connectivity
- 2 Digital Inputs/ 2 Digital Outputs [optional]; Power reserve in case of power failure [optional]
- VPN through IPsec or OpenVPN. Maximum 10 Tunnels

MB5901B All-in-one 3G/4G to Ethernet or Serial Modbus Gateway (-40~75°C)

- Same hardware features of SE5901B, plus
- Seamless Modbus TCP/RTU/ASCII conversion from/to Ethernet/Serial or Cellular
- Advanced Modbus management features, like device ID virtualization
- VPN through IPsec or OpenVPN. Maximum 10 Tunnels

PG5901B All-in-one 3G/4G to Eth or Serial DNP3, Modbus, IEC61850 and IEC60870 Protocol Gateway (-40~75 °C)

- Same hardware features of SE5901B, plus
- Seamless conversion between Modbus TCP/RTU/ASCII, DNP3.0 TCP/Serial, IEC 60870-5-101/-5-103/ -5-104 and IEC 61850 all in master/slave mode
- Easy and fast to configure
- VPN through IPsec or OpenVPN. Maximum 10 Tunnels

Fast responsiveness

Integrating legacy equipment with new infrastructure always has a common problem on speed or data throughput mismatch. **New technologies offer much wider bandwidth and have more and stricter requirements in the matter of responsiveness.**

Driven by innovations and new technologies, grids today respond promptly to our changing energy demands. Old ones are generally slow and do not have as frequent data update as new one. ATOP managed to solve this problem in a number of ways.

For example, several power-specific switches embed hardware-based High-Availability Redundancy with Gigabit throughput capability. Also, our data concentrators can autonomously poll data from intelligent electronic devices (IEDs) or remote terminal units (RTUs) and store them in the internal memory until the programmable logic controller (PLC) or the master running on the new protocol or on the new physical layer asks for an update. This helps reducing bottlenecks and greatly increases system performance.



SCADA

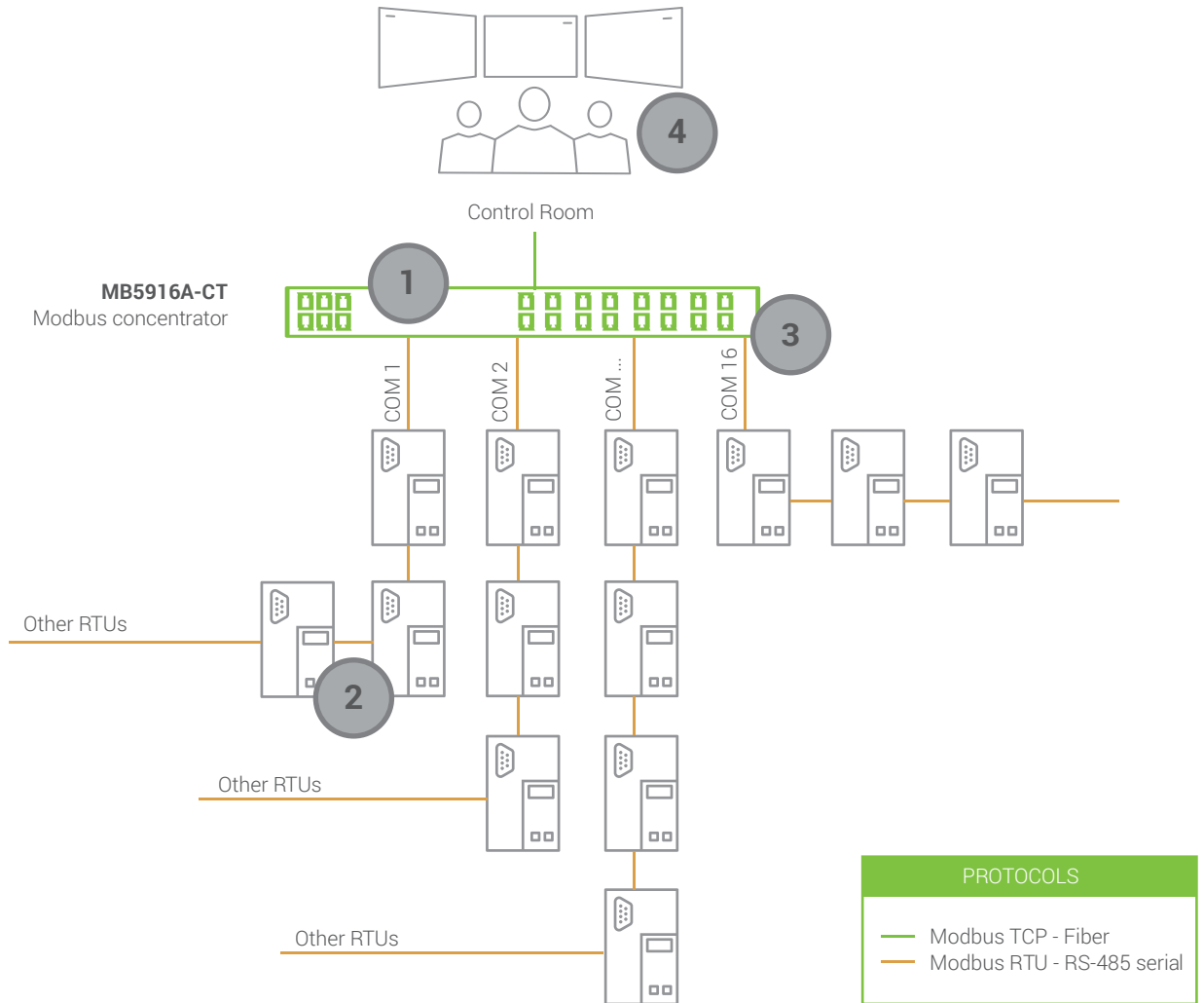

OPERATION'S LOGIC

- 1 ATOP's concentrator autonomously and routinely polls the IEDs through the low-speed RS-485 interface
- 2 The slave devices return the register value to ATOP's concentrator according to the polling requests.
- 3 The concentrator stores the data in its internal memory and waits for a polling command from the master, on the high-speed interface. This will poll device ID # 248
- 4 When polling command is received, the data is relayed directly to the master from the internal memory without the need to wait until all slaves return the requested values to the master

IEC 61850

Over the last few decades, various countries around the globe have developed, promoted, and adopted different communication protocols for use between components (such as Control Centers, Remote Terminal Units, Intelligent Electronics Devices) and for network management in electrical power grid. In the North American countries, Distributed Network Protocol (DNP) 3.0 became the de facto standard which also adopted by IEEE as IEEE Std. 1815-2012, while European countries relied mainly on IEC 60870-5-101/103/104. The rest of the world adopted Modbus protocol due to its openness and simplicity.



The attempts to develop a unified and standardized communication protocol for electrical substation and power grid automation succeeded in so-called IEC 61850 standard.

The new IEC 61850 standard facilitates interoperability and communications among "Intelligent Electronic Devices (IED)" in substations. It focuses its domain knowledge on the electrical power grid system. It is an object oriented protocol where it utilizes data modeling scheme that clearly describes each component of the grid or the substation as standard logical nodes. This enables data access to the power grid system to yield more details than ever before.

IEC 61850 Part 3 also defines requirements for network and hardware that are suitable for substation automation. These requirements include electromagnetic immunity (EMI), surge protection, vibration resistance, shock resistance, and temperature ranges that the devices in smart grid system should comply to.

IEC61850 also sets standards for other fundamental aspects in the power grid automation:



Traffic Optimization & packet Prioritization according to IEEE802.1p/q



Precision Time Protocol Time Synchronization according to IEEE1588v2 for nanosecond accuracy



HSR-PRP Zero-packet loss Redundancy Mechanisms



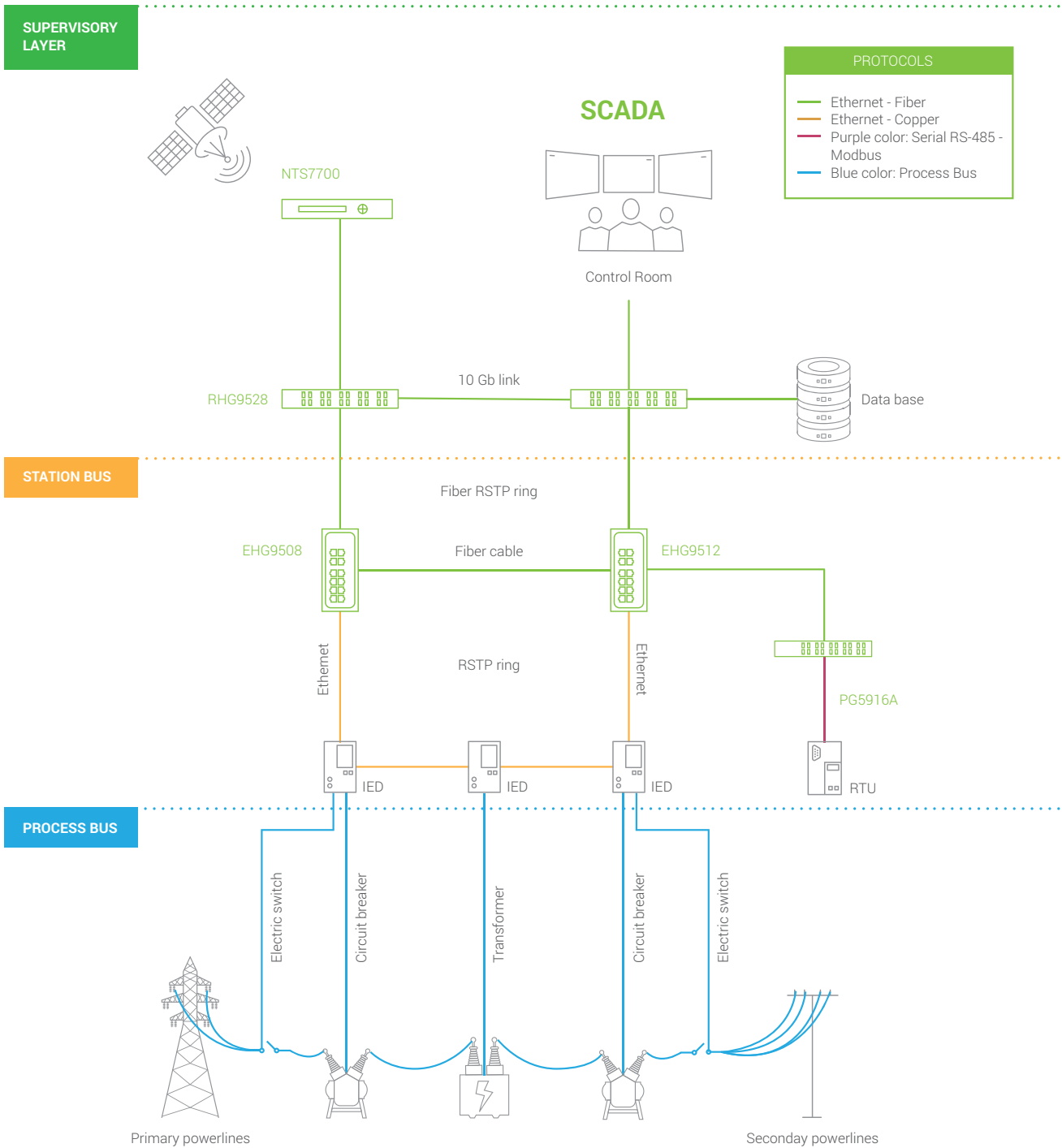

FEATURED PRODUCTS

<p>RHG9528 - 28 Port switch</p> <ul style="list-style-type: none"> • Rack-mount IEC 61850-3 Certified Gigabit managed switch • HSR/PRP High-Availability • Modular architecture (8 port SFP 100/1000, 8 port 10/100/1000 RJ45 ports or 4-port RJ45/SFP HSR/PRP module) with maximum 24 ports. • Additional 4x1/10-Gigabit uplinks • Hardware IEEE1588v2 BC/TC • -40 / 85°C operation 	<p>PG5916A - Protocol gateway</p> <ul style="list-style-type: none"> • 6x10/100 RJ45 Ethernet ports or 6x100 STOP ports. • 8-16-20 RS485-RS232-RS422 serial ports. • DNP3, Modbus, IEC 61850, IEC 60870-5-101/103/104 protocol gateway. • Redundancy option. 	<p>NTS7700</p> <ul style="list-style-type: none"> • Grandmaster clock with GPS/GLONASS/BEIDOU capability. • Embedded IEEE1588 v2 Precision time Protocol with many options. • SyncE for Telecom • Holdover accuracy ≤ 1.5us/day. 	<p>EHG9508</p> <ul style="list-style-type: none"> • 8-port IEC61850-3 certified Gigabit switch • 2x1G SFP uplinks • Hardware IEEE1588v2 End-to-End transparent clock 	<p>EHG9512</p> <ul style="list-style-type: none"> • 12-port Gigabit IEC 61850-3 certified managed switch • 4x1G SFP uplinks • Hardware IEEE1588v2 End-to-End transparent clock
---	---	---	--	--

Ethernet Switches for the Power Grid

ATOP's range of industrial Ethernet switches are engineered for use in harsh industrial environments. We help you develop cost-effective and secure networks for critical power grid infrastructure without having to worry about implementation and reliability. With our extensive range of switches and knowledge of various protocol standards, we have formed power grid communication backbones for many companies across continents— regardless of environment and scale.

Switches for Substation Automation and Smart Grids

With a goal to optimize substation network availability, ATOP has in store several robust IEC61850-3 certified switches in both DIN-rail and Rack-mount options for applications either closer to the field or for data aggregation requiring large throughput and reliability.

All switches provide redundant power inputs and two sets of relays that allow the user build up a stand-alone fault alarm system. Its wide operating temperature of -40 to 85°C make ATOP Power-Switches suitable to be used in remote substations where harsh environment and reliability are major hindrances.

If substation data aggregation and a high degree of redundancy is your need, the modular rack-mount switch, for up to 24 Gigabit + 4x10 Gigabit ports, Up to 4 Gigabit HSR/PRP ports also supporting coupling and quadbox, and IEEE1588v2 Precision Time Protocol Hardware-assisted Transparent Clock or Boundary Clock.

RHG9528, in its Precision Timing Variant, supports IEEE1588v2 HW TC/BC in both peer-to-peer and end-to-end mode, with full support for IEEE/IEC61850-9-3:2016 and IEEE37.238-2017 Power Profiles. More new products are on the way.

HIGH AVAILABILITY APPLICATION

Zero packet loss, on multiple ports

Install a 4-port Gigabit RJ45 or SFP High-Availability module in any of the module slots in RHG9528 CPU board, and you're good to go. Congratulations, your network is now fully compliant with IEC62439-3 Clause 4- 2016 (PRP) and IEC62439-3 Clause 5-2016 (HSR). Simultaneously, through this 4-port module, you will have a powerful quadbox at your disposal: you can use 4 ports in HSR mode, in PRP mode or have 2 Ports working in an HSR Ring while other 2 working in PRP. This will provide you flexibility when integrating the switch in a complex topology, achieving zero-loss redundancy and zero-time recovery.

Through HSR/PRP technology, ATOP's device will replicate the packet through 2 redundant paths and the end-application will have the risks to lose a packet almost zeroed. This is an example of a mixed HSR/PRP network, where RHG9528 is used flexibly as a Transparent or a Boundary Clock and as an HSR/PRP manager.

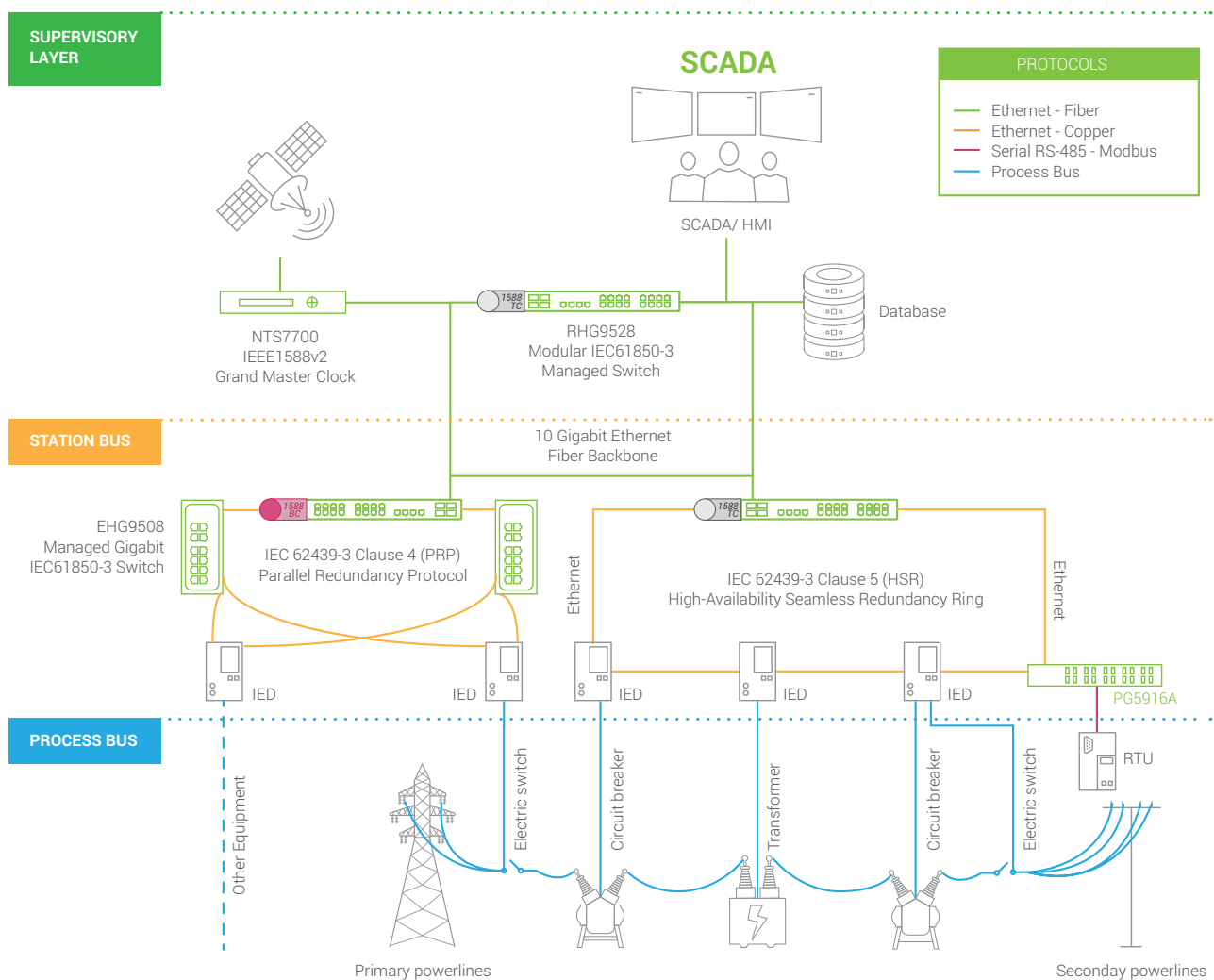

IEEE1588v2 PTP, IEC61850-9-3 Power Profile and HSR/PRP

RHG9528 is an advanced and flexible modular configuration. It embeds high-bandwidth Switching fabric, accurate non-transparent, hardware-based Boundary Clock or Transparent Clock for variable delay computing, IEC61850-3 compliant hardware, and fully supports IEC/IEEE61850-9-3:2016 Power Profile. Also on HSR/PRP ports. When properly configured, our Switch can seamlessly provide Peer-to-Peer transparent clock and Boundary Clock on all ports, HSR/PRP ports included.

Time Synchronization in next generation's Power Grid

IEC 61850 requires all IEDs inside the network to be synchronized, preferably with IEEE 1588v2 Precision Time Protocol. This allows precise event and data timestamping and can help the supervisors understand what went wrong and in which exact sequence. Precise time synchronization is required to ensure that substation devices have accurate clocks for system control and data acquisition etc. The precision is far beyond SNTP or NTP where accuracy is in milliseconds (10^{-3} s): PTP achieves nanosecond accuracy (10^{-9} s).

But Precision Time Protocol is not only for substations: it is a fundamental element in cellular wireless networks (such as 4G and 5G) and it is extremely important in HFT platforms (High Frequency Trading) and banking.

ATOP provides a full IEEE 1588v2 solution, from time generation to transparent clock.

IEEE 1588v2 Precision Time Protocol

The IEEE 1588 standards describe a hierarchical master-slave architecture for clock distribution, a protocol used to synchronize clocks throughout a computer network. Under this architecture, a time distribution system consists of one or more communication media (network segments), and one or more clocks. An ordinary clock is a device with a single network connection and is either the source of (master) or destination for (slave) a synchronization reference. A boundary clock has multiple network connections, absorbs sync messages in the slave port, uses that port to set its clock and accurately synchronizes one network segment to another. A synchronization master is selected for each of the network segments in the system.

The root timing reference is called the grandmaster. The grandmaster transmits synchronization information to the clocks residing on its network segment.

The boundary clocks with a presence on that segment then relay accurate time to the other segments to which they are also connected.

Primary timing source for a Grandmaster Clock where all clocks are synched to is either the GPS or GLONASS, GALILEO, BEIDOU satellite systems. Being positioning satellites accurate atomic clocks, the GM can compute the exact timing with extremely low error.



PTP Elements

GNSS
As an external clock source, GNSS' Atomic Clock provides highly accurate absolute time to the GM.

Grandmaster
Highly accurate clock that is the ultimate source of time for network synchronisation using PTP.

Transparent Clock
Ethernet switch that forwards PTP packets transparently, only modifying selected fields during pass-through.

Boundary Clock
Located between two or more network segments, it acts as a slave clock to devices upstream, and as a master to devices downstream.

Slaves
A slave clock uses IEEE 1588 protocol to synchronize its internal System Time to the BMC selected master clock.

ATOP 1588NetSync



Synchronization is critical when devices working at a distance from each other need to work in tandem. ATOP provides full IEEE 1588 v2 solutions, ranging from Grandmaster clock which acts as the source of time in a PTP network to Transparent/Boundary clocks for hardware timestamps. Advanced industrial L2 and L3 managed switches, specifically EHG7XXX, RHG7XXX, EHG9XXX and RHG9XXX families support IEEE1588v2 hardware-assisted transparent End-to-End clock and software-assisted boundary clock.

As a **Grandmaster**, ATOP's NTS7700 Grandmaster clock with high precision GNSS module provides a reliable and fault-tolerant solution for substation, telecom and HFT requirements. IEC61850-3 Certified, embeds 2 x 100/1000 Mbps SFP slots and 2 x 10/100/1000 Mbps RJ45 ports and supports IEEE1588v2 in Multicast, Unicast and Unicast Negotiation modes, NTP and SNTP server and can be enhanced supporting IRIG-B legacy time distribution through its expandable design.

The integrated circuitry guarantees an accuracy of +15ns when the device is locked to GNSS and the high-accuracy OCXO oscillator ensures the overall drifting to be maximum 1.5 microseconds a day when the Grandmaster loses its connection to the GPS satellites. NTS7700 supports GPS, GLONASS, GALILEO and BEIDOU GNSS Systems.



• Want to learn more? Detailed information available in ATOP's Precision Timing Whitepaper and in the datasheets.

Substation retrofitting

IEC 61850 standard saw quick adoption from utilities across the world. It not only enabled high levels of interoperability between devices from different manufacturers but also provided advanced means of communication. Electrical grid system is a large power distribution network that went through decades of development. Generally, the power utilities invest in the latest technologies available to them at the times of their installations such as the latest IEC 61850 compliant equipment.

However, the life-time of the equipment in the grid system can typically span several years as a life-cycle of a substation can be more than 50 years. Replacement of latest devices ahead of time is out of the question due to their substantial investments. Therefore, the legacy equipment will normally remain in use and the power grid is naturally equipped with both legacy and new technologies. The challenge for the smart grid system is to continue developing the power grid with a focus on enabling enhanced monitoring and control across the electrical distribution network by integrating newer and legacy technologies with seamless control and supervision.

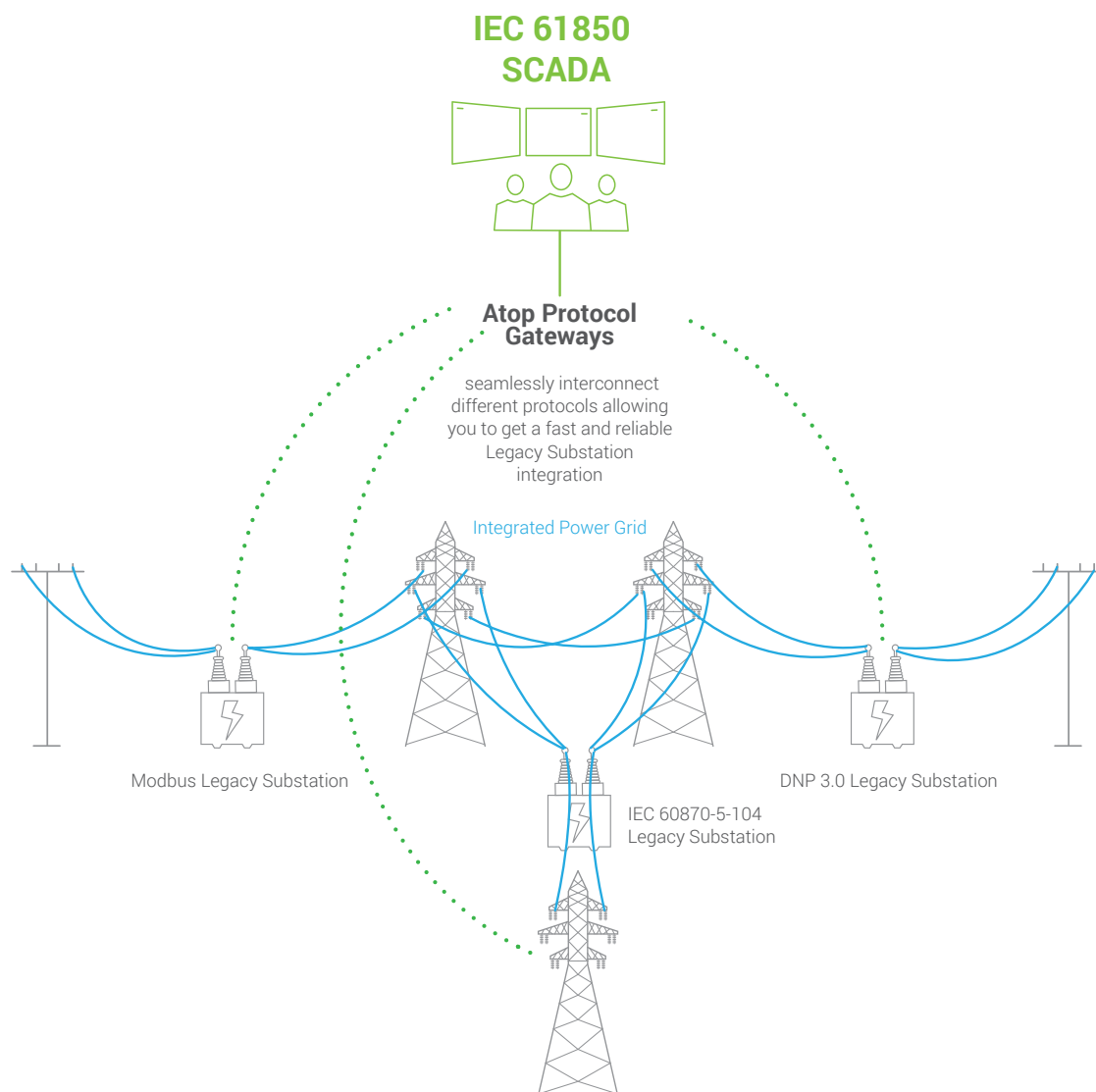

Integrating Legacy Protocols in the Smart Grid

ATOP's broad product range has been specifically designed to allow seamless integration as simple as possible. Legacy substations operating with outdated or unpopular protocols may remain in place and can be connected to the new network through ATOP's Protocol Gateways. Our powerful hardware platform with a stable and reliable software will manage the translation from protocol to protocol transparently. As a highly reliable and fault-tolerant industrial Protocol Gateways featuring integrated 3G/4G connectivity.

ATOP's user-friendly configuration tool will help the customer or the system integration to map data points. Rugged and reliable, they command within minutes by enabling the customer to manage changeovers, upgrades, or integrations in a fast and cost-effective way.

To support the customer easily handling these challenges, ATOP offers more than 80 different protocol combinations that are available on 10 different hardware platforms empowering the customer to choose among hundreds of different products!

Protocol	Interface	Function
Modbus RTU	RS-485 ; RS-232 ; RS-422	Master/Slave
Modbus TCP	Ethernet	Client/Server
DNP 3.0 over Serial	RS-485 ; RS-232 ; RS-422	Master/Slave
DNP 3.0 over Ethernet	Ethernet	Client/Server
IEC 60870-5-101	RS-485 ; RS-232 ; RS-422	Master/Slave
IEC 60870-5-103	RS-485 ; RS-232 ; RS-422	Master/Slave
IEC 60870-5-104	Ethernet	Client/Server
IEC 61850	Ethernet	Client/Server

Hardware platforms

	Hardware	Mount	Ethernet Ports	RS-485 RS-232 RS-422 ports	Additional features
	PG5901	Din-Rail	2 (RJ45)	1 (TB5 or DB9)	can be PoE-powered [optional]
	PG5901B	Din-Rail	1 (RJ45)	1 (DB9 vers.) / 2 (TB14 I/O vers.)	4G LTE or 3G connectivity
	PG5904D-4P	Din-Rail	2 (RJ45 or SFP)	4 (TB5 or DB9)	can be PoE-powered [optional]
	PG5908	Rack-Mount	2 (RJ45)	8 (RJ45)	
	PG5916	Rack-Mount	2 (RJ45)	16 (RJ45)	
	PG5900A	Rack-Mount	6 (SFP or RJ45)	-	
	PG5908A	Rack-Mount	6 (SFP or RJ45)	8 (TB5 or DB9)	
	PG5916A	Rack-Mount	6 (SFP or RJ45)	16(TB5 or DB9)	

• Want to learn more? Detailed information are available in ATOP's Product selection guide or on the Datasheets.

Success stories



PROJECT-BASED SOLUTIONS-IEC 61850

System description: The customer would like to manage via Modbus TCP SCADA the substation infrastructure that is IEC 61850 client and the introduction of a high degree of redundancy in the event of a link, IED, switch or device failure

Application:

- High to Medium Voltage substation

Location:

- Indonesia

Main protocol used:

- Field side; IEC 61850
- Control side; Modbus TCP/RTU

Requirements:

- High degree of data redundancy, IEC 61850-3 compliant hardware

Solutions provided:

- Support to System integrator in defining the Ideal Network Topology for the application
- Custom designed redundant IEC 61850 Concentrators with Fiber Uplink, protocol gateway to the redundant Modbus backbone
- Managed 61850-3 compliant switches with RSTP
- On-site setup, configuration, test and troubleshooting

IMPLEMENTATION DETAILS

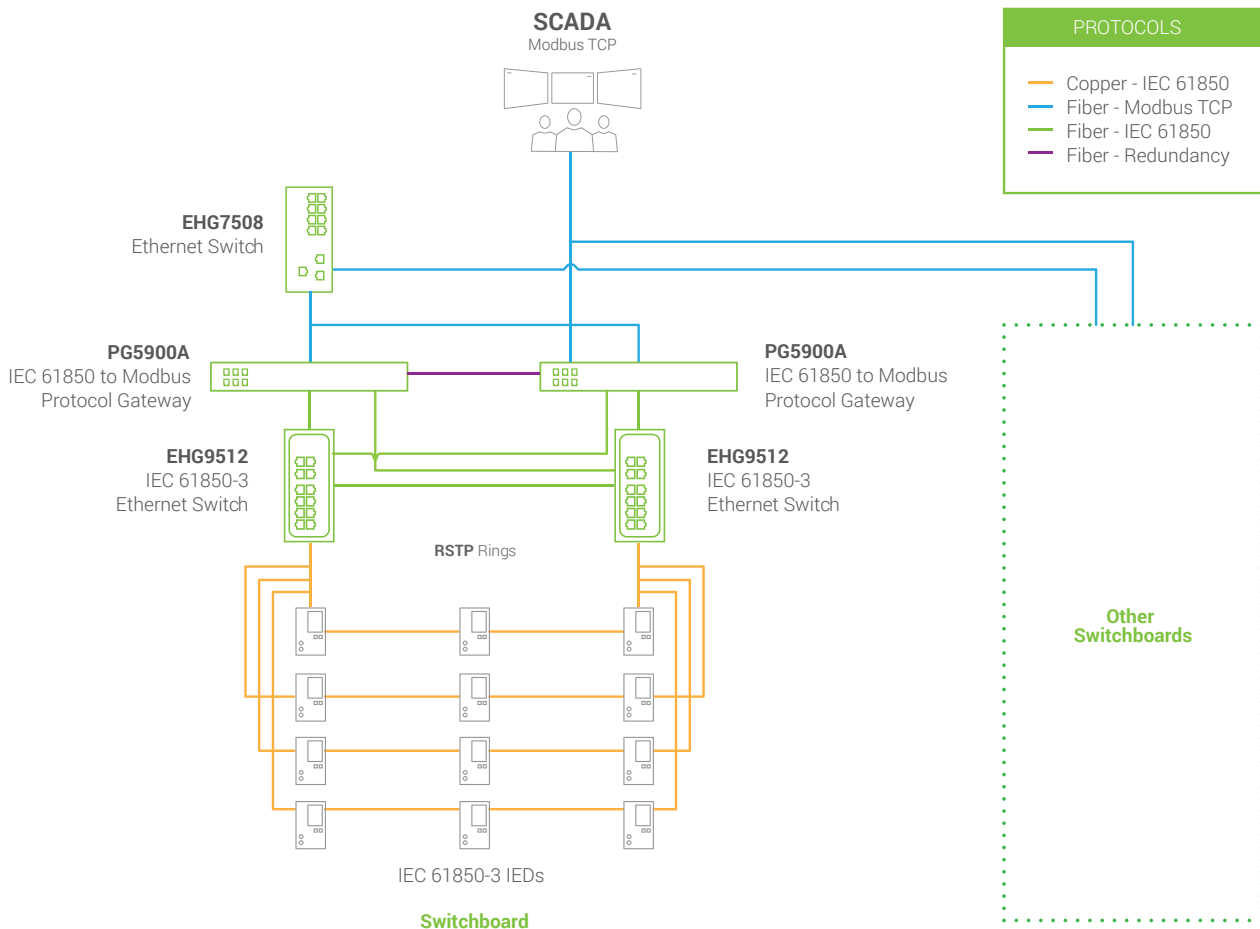

MAIN FEATURES / DESIGN REQUIREMENTS

- Link Recovery time is <600 ms with RSTP topology
- The Protocol Gateway will automatically poll each IED automatically via Ethernet (IEC 61850-3) and convert data to Modbus.
- The obtained data will be remapped in a memory in a way to be easily accessible, for any specific enquiry from the master (Modbus TCP) and will be returned with high speed.
- High degree of redundancy: in order to have a device unaccessible multiple links should be broken simultaneously
- Architecture is designed in a way that link failures will be detected and the second concentrator can take over the job, issuing relay alarms and specific status registers change to immediately inform control room of malfunction
- Design is EMC level 3-4, IEC 61850-3 certified

FEATURED PRODUCTS



EHG9512 IEC 61850-3 8-Port Gigabit Managed Switch (-40~85 °C)

- 8 x 100/1000 RJ45 ports and 4 Gigabit SFP uplink slots
- IEC 61850-3, IEEE 1613, UL/cUL/IEC(CB) 61010-2-201 certified
- IEEE 1588v2 Hardware-assisted TC and many others



PG5900A – Redundant Protocol Gateway (-40~85 °C)

- 6 Fast Ethernet RJ45 or SFP ports
- Seamless conversion between Modbus, DNP3, IEC 60870-5-101/3/4 and IEC 61850 all in master/slave mode
- Can be set-up in redundant couples in order to have a fault-proof system
- IEC 61850-3, IEEE 1613, IEC(CB) 61010-2-201 certified

Modbus Gateways

Since its introduction, **Modbus has become one of the most popular protocols used worldwide. Modbus RTU (through serial connection) and Modbus TCP (through Ethernet networks) are often used as backbone of industrial automation, substation automation, and building automation.**

Because of its lightweight, broad market penetration, ATOP creates a specific product line for Modbus devices. The slow migration of the communication standard from serial-based (RS-232, RS-485, and RS-422) devices to Ethernet-based devices introduces the need of smart converters.

Overview

From simple to complex applications, ATOP has 10 products supporting Modbus in a wide variety of options between ethernet-based Modbus TCP and serial-based Modbus RTU/ASCII. ATOP's entry-level products provide seamless conversion of Modbus RTU to Modbus TCP with almost no configuration required. ATOP's devices are available from one to sixteen serial ports and with flexibility in their installation using DIN-rail, Field Mount, or Rack-Mount. An advanced LTE version also enables recent high-speed wireless communication for Modbus protocol.

Our products are enhanced with harsh environment operational capability, vibration resistance, power or serial port isolation for equipment and device protection, redundant power supplies, and many more special options. For the most critical application, ATOP provides additional reliability through redundancy function and supports enhanced responsiveness through concentrator function.



Concentrator

Data concentrator function of collecting all information as agent is a unique feature in ATOP's Advanced Modbus Gateways. This feature is ATOP's proprietary mechanism for responsiveness enhancement. Generally, a Modbus Gateway is working in the following manners. It waits for a master device's request, then converts and relays information to a field device. Once a response is returned from the field device, the response is then converted and relayed back to the master device.

This has significant negative impact on the responsiveness. Instead, ATOP's Advanced Modbus Gateways with data concentrator function will continuously poll (at an interval specified by the customer) IEDs autonomously and store the data in their internal memory waiting for master device's requests. Once the request arrived, the return data will be retrieved from the internal memory of the Modbus Gateways. This has several positive implications on the system performance: the master device may need just one connection and one query to get all data at once, the response time will be dramatically reduced, and many different data structures can be accessible based on specific need.

• Want to learn more? Detailed information available in ATOP's Protocol Selection Guide and in the datasheets.



Redundancy

ATOP's Advanced Modbus Concentrators can be embedded with additional redundancy feature implemented through ATOP's proprietary communication protocol. For instance, several IEDs can be connected in multiple chains through serial ports where the primary Modbus Gateway and the secondary Modbus Gateway are connected on different ends of the chains as shown in the figure below. There can be an Ethernet link with either fiber or copper connection between the primary gateway and the secondary gateway. Both primary and secondary gateways may be further connected to a master through different redundant rings.

In normal situation, the secondary gateway will be silent, listening, and recording the data. In the event of a network breakdown, one of the gateway that is still reachable will take over communication with the master and relay back the link requested data to the master together with a link failure notification. One the other hand, if there is a serial link failure, the secondary gateway will autonomously poll the missing data and update the primary gateway memory ensuring the data relayed to master is complete.

This feature enables the customer to manage the network with much fewer down-times than ever. It also provides additional safety feature protecting the utility or the substation from accidental or intentional failure arising from the outside of the system.

Concentrator & Redundancy : a case study



Modbus Redundant Concentrator

Challenge: To manage via Modbus TCP SCADA a large low-voltage substation infrastructure that is Modbus RTU-based. It's a complex infrastructure, with each switchboard involving around 190 slaves that need to be accessed simultaneously for data, diagnostics, and configuration.

Location: Petrochemical and Refinery Complex, Malaysia

Protocol used: Modbus TCP/Modbus RTU.

Requirements: Short failure recovery time; very efficient Modbus polling in an environment with a high density of devices.

Challenges

- Supporting system integrator to define the topology.
- Customizing hardware with redundant Modbus concentrators with fiber uplink – 16 serial ports.
- Adjusting command priority to ensure each poll command can be executed within 600ms.
- Integration of customer's device management tool.
- On-site setup, config., test and troubleshooting.
- User-friendly configuration: to develop a colored-block UI to identify memory area -enabling easy set up of the memory mapping.

Solution provided

- Modbus redundant concentrators were designed and set up in pairs, with redundancy fiber link between them and COM links that started from one device and end with the other one.
- Software customization and optimization.
- Managed Ethernet switches providing the backbone to the customer's EWS.

Results achieved

- 600 ms complete polling for more than 100 slaves, each with 20 registers (19200 bps).
- 500 ms secondary recovery to handle primary device downtime or device failure.
- Multi-write command to map different slaves simultaneously to improve efficiency.

Network Topology

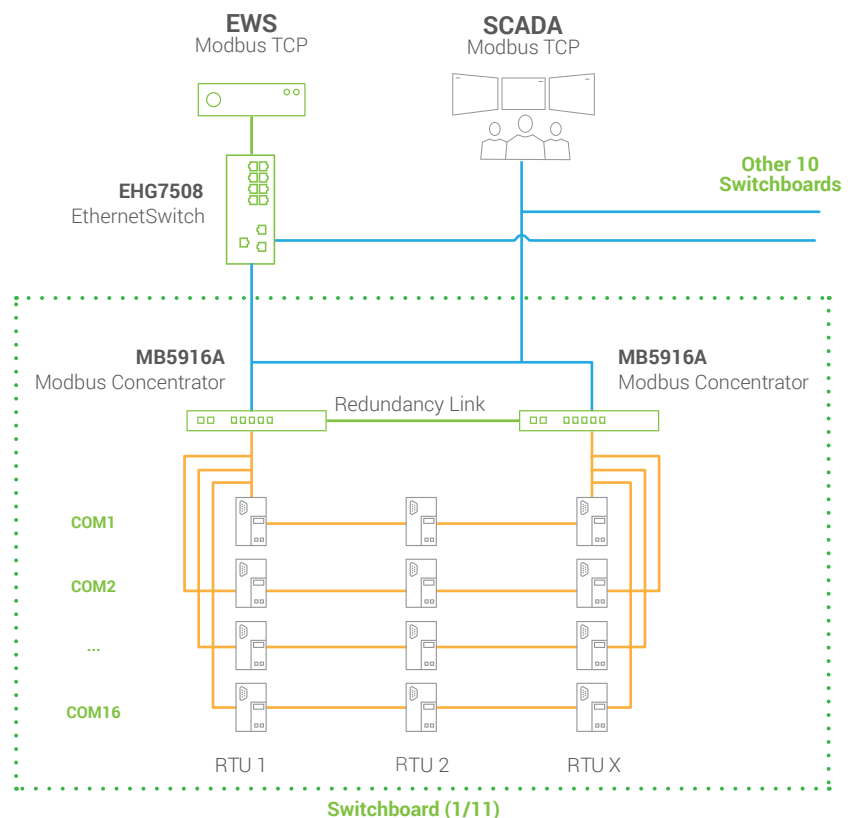

Ordinary operation

- During startup, one concentrator takes the role as primary and the other one, secondary.
- The two devices share the same configuration and they are connected with a redundancy Ethernet link.
- The serial port polling activity is carried out by the Primary device. Being the serial devices connected in a line from the primary to the secondary, the secondary device remains silent since it receives all data as per its configuration.
- The polled coils/registers are stored in the device's memory and rearranged, as it's more convenient for SCADA to access. Additional information on device status and time-stamping has been made available.
- SCADA polls from one of the two concentrators, that sync their database in the background.

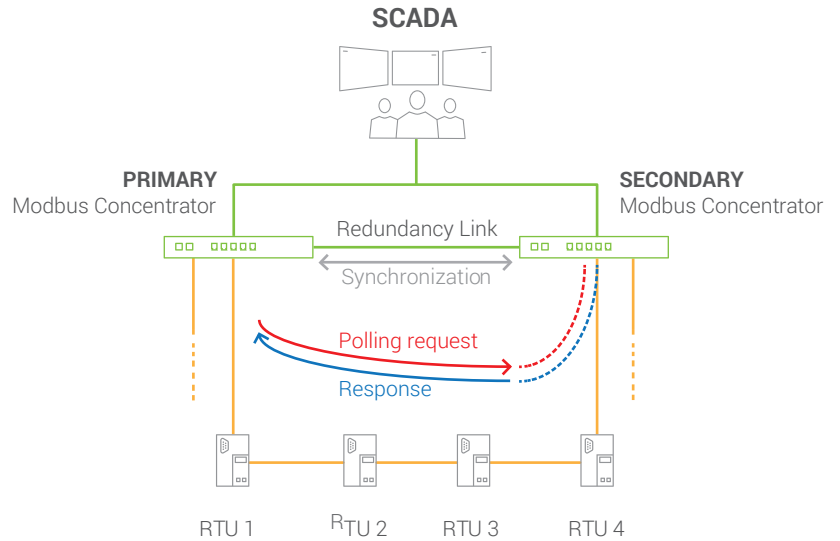

Serial line is broken

- In the example shown, the RS-485 line between IED 1 and IED 2 is broken. IED 2,3,4 can be accessed only from the Secondary concentrator side. IED 1 can be accessed only from the Primary Gateway.
- After Primary polls IED 1 and syncing data with the secondary, the latter will notice IED 1 data wasn't received. This exception will be available as a dedicated register for diagnostics.
- After not receiving any response from IED 2 and having a timeout, Primary will ask Secondary to poll the device, assuming the line is broken.
- When successful, Secondary will sync this with Primary. The data will anyway be available for the SCADA from primary device, seamlessly.
- Exception will be available as dedicated register.

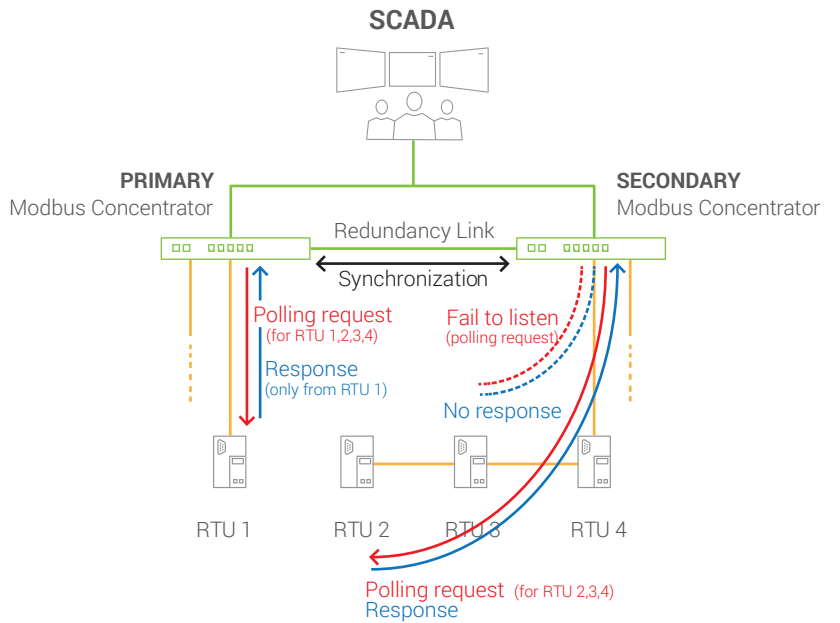

Device failure

- In case secondary device fails to receive any serial polling from primary and there is no response from the redundancy link, secondary will assume the other device to be down. Secondary will take over the primary role.
- SCADA will switch to poll secondary device.
- The Primary failure status will be available through dedicated Modbus registers for diagnostics.
- If the failed device returns back online, it will renegotiate its status and will act as a secondary concentrator with reference to poll and response to the SCADA host.

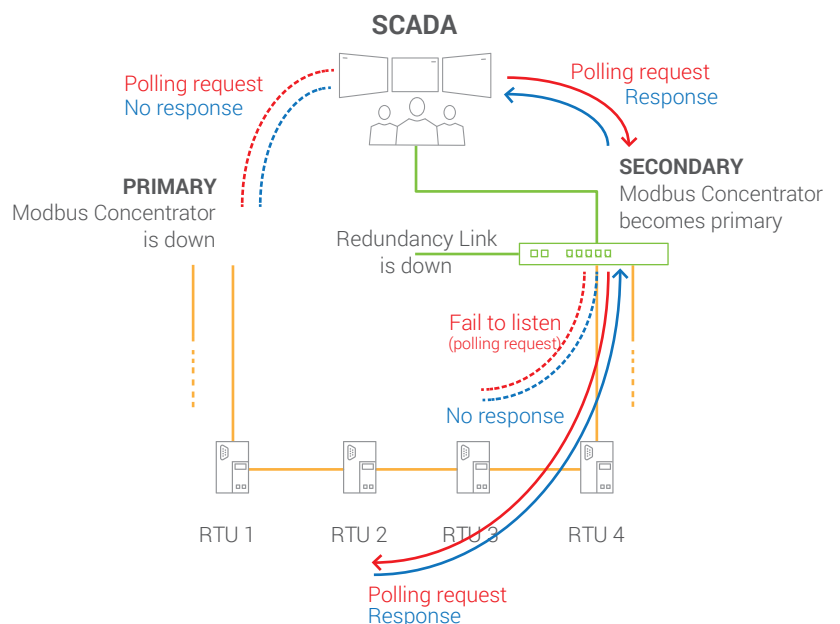



TAIWAN HEAD OFFICE

2F, No. 148, Sec. 1, Tung-Hsing Rd,
30261 Chupei City, Hsinchu County
Taiwan, R.O.C.
Tel: +888-3-550-8137
Fax: +886-3-550-8131
E-mail: sales@atop.com.tw

ATOP INDIA OFFICE

Abhishek Srivastava
Head of India Sales
Atech Solutions(P) Ltd.
No. 311, 6th Main Rd, Indiranagar
Bangalore, 560038, India
Tel: +91-80-4920-6363
E-mail: Abhishek.S@atop.in

ATOP GERMANY OFFICE

Matteo Tabarelli de Fatis
Senior Vice President (Operations)
Auwaldstraße 8, 96231
Bad Staffelstein, Germany
Tel: +49-172-8181-556
E-mail: Matteo.Tabarelli@atop.com.tw

ATOP WESTERN EUROPE & UK

Prashant Mishra
Head of Western Europe Sales
Atech Solutions(P) Ltd.
No. 311, 6th Main Rd, Indiranagar
Bangalore, 560038, India
E-mail: Prashant.m@atop.in

ATOP EAST EUROPE, EMEA

Bhaskar Kailas (BK)
Vice President (Business Development)
Atech Solutions(P) Ltd.
No. 311, 6th Main Rd, Indiranagar
Bangalore, 560038, India
Tel: +91-988-0788-559
E-mail: Bhaskar.k@atop.in

ATOP AMERICAs OFFICE

Venke Char
Sr. Vice President & Head of Business
11811 North Tatum Blvd, Suite 3031
Phoenix, AZ 85028, United States
Tel: +1-602-953-7669
E-mail: venke@atop.in

ATOP CHINA BRANCH

3F, 75, No. 1086 Building,
Qingzhou North Road
Shanghai, China
Tel: +86-21-64956231

ATOP INDONESIA BRANCH

PT.Atop Indonesia Technologies
Wisma Slipi, Jl. Let.Jend. S. Parman Kav. 12,
Unit : 308, Jakarta Barat 11480
Indonesia
Tel. (+62-21)5326171
Fax. (+62-21)5326172
E-mail : jopsonli@atop.com.tw

