



Atop Technologies, Inc.

**Industrial Serial Device Sever
Industrial Modbus Gateway**

SE5202 / MB5202 Series

Hardware Installation Guide

Version 2.0
Updated in January, 2019



Tel: 886-3-5508137
Fax: 886-3-5508131
www.atop.com.tw

P/N : 89900555G

Package Check List

Inside the package you will find the following items:

- Industrial Serial Device Sever x 1
- 3-Pin Terminal Block x 1 or 5-Pin Terminal Block x 1 (Depend on model)
- Wall mount screws x 2
- Installation Guide with Warranty Card x 1

Product Layout

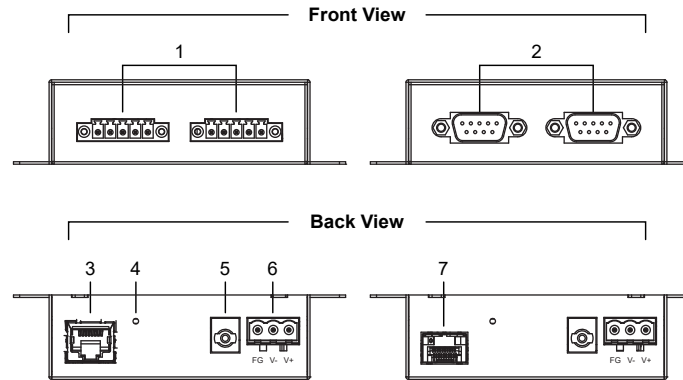

1. COM Port - Terminal Block
2. COM Port -DB9
3. 10/100M LAN Port
4. Reset
5. DC Jack Power Input
6. Terminal Block Power Input
7. SFP Slot
8. LAN LED
9. COM2 LED
10. COM1 LED
11. RUN LED

Installation Overview

The device's appearance is as in the figure below.

1. If you have purchased the wall mount kit, proceed to place the screws on the back of the device as show in (Fig. 1).

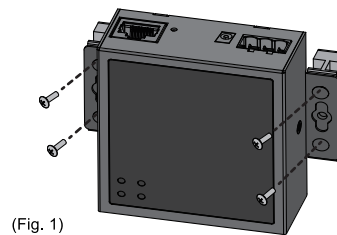

2. Although internal grounding has been done inside, in order to ensure overall maximum performance and protect your device, it is still strongly advised to ground the device properly; hazardous ESD can come into contact and damage your equipment. On the power terminal block, there is a terminal for Frame Ground, you can choose whether to connect it to the grounding or you may opt to connect to the grounding screw next to the terminal block (the one chosen should be connected at all times) (Fig. 2)

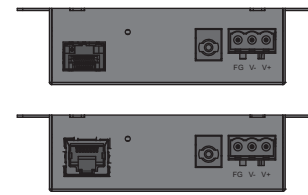

3. You can then choose whether to plug in the other peripheral ports at this point or do it later depending on the actual location of the device or level of comfort for performing such operation.

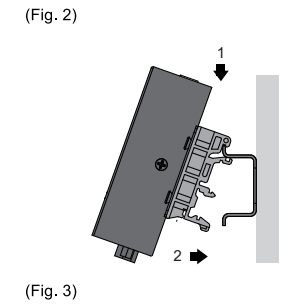

4. Once the plate has been firmly put in place, proceed to mount the whole device as shown in (Fig. 3). Proceed to (Fig. 4) if you want to remove the device from DIN-Rail.

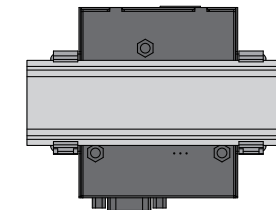
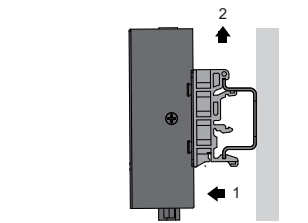

5. Next we can then proceed to connect the device to the LAN (switch or PC, depending on the case), take care on using the RJ-45 connector; after this we can then proceed to the device's settings

- The opening to the sides are for the device's heat dissipation please never obstruct or cover them with any objects or try to insert them through it.
- The Serial Sever's factory IP by default is 10.0.50.100 Web UI once it is connected to a physical network (or using Management Utility, for more information on Management Utility, please refer to its manual). Please be aware that the PC needed for this procedure needs to be in the same subnet, or you may refer yourself to the device User's Manual.

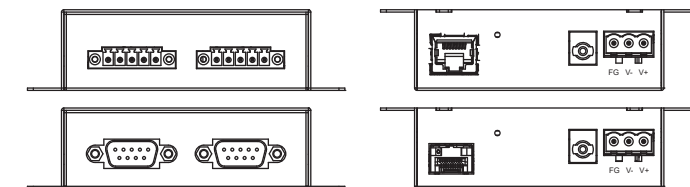

LED Indicators

LED	Color	State	Description
RUN	Green	On	System is booted up and not running AP
		Blinking	System is booted up and running
		Off	System is still booting up or powered off
LAN	Orange	Blinking	Transmission is active (10Mbps)
		Off	No transmission is made
	Green	Blinking	Transmission is active (100Mbps)
		Off	No transmission is made
COM	Green	Blinking	COM is transmitting/receiving
		Off	COM is not transmitting/receiving

Power Requirements

Power Input of Terminal Block : 9-30V DC; 0.3mA max.

Power Input of DC Jack : 5V with power adapter only

Pin Assignments and Connections

10/100BASE-T(X) Ethernet Pinouts

RJ-45	10/100BASE-T(X)							
	1	2	3	4	5	6	7	8
Signal	Tx+	Tx-	Rx+			Rx-		

Serial Ports

DB9			
Pin	RS-232	RS-422 and 4-wire RS-485	RS-485 (2W)
1	DCD	-	-
2	RxD	TxD+	Data+
3	TxD	RxD+	-
4	DTR	-	-
5	SG	SG	SG
6	DSR	-	-
7	RTS	RxD-	-
8	CTS	TxD-	Data-
9	RI	-	-

Terminal Block			
Pin	RS-232	RS-422 / 4-W RS-485	2-W RS-485
1	RxD	TxD+	Data+
2	CTS	TxD-	Data-
3	TxD	RxD+	-
4	RTS	RxD-	-
5	SG	SG	-

Terminal Block for Power input

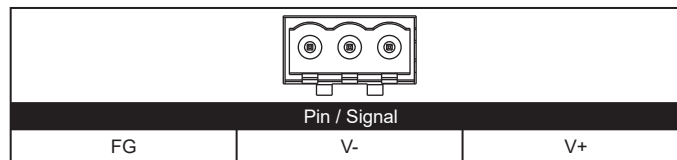

Field Maintenance and Service

If the device requires servicing of any kind, you may need to disconnect and remove it from its mounting. The initial installation should be done in a way that makes this as convenient as possible.

- Voltage/Power lines should be properly insulated as well as other cables. Be careful when handling the so as to not trip over
- Do not under any circumstance insert foreign objects of any kind into the heat dissipation holes located in the different faces of the device. This may not only harm the internal layout but might cause harm to you as well.
- Do not under any circumstance open the device for any reason. Please contact your dealer for any repair needed or follow the instructions on section of your User's Manual.

Mechanical Dimensions (Unit=mm)

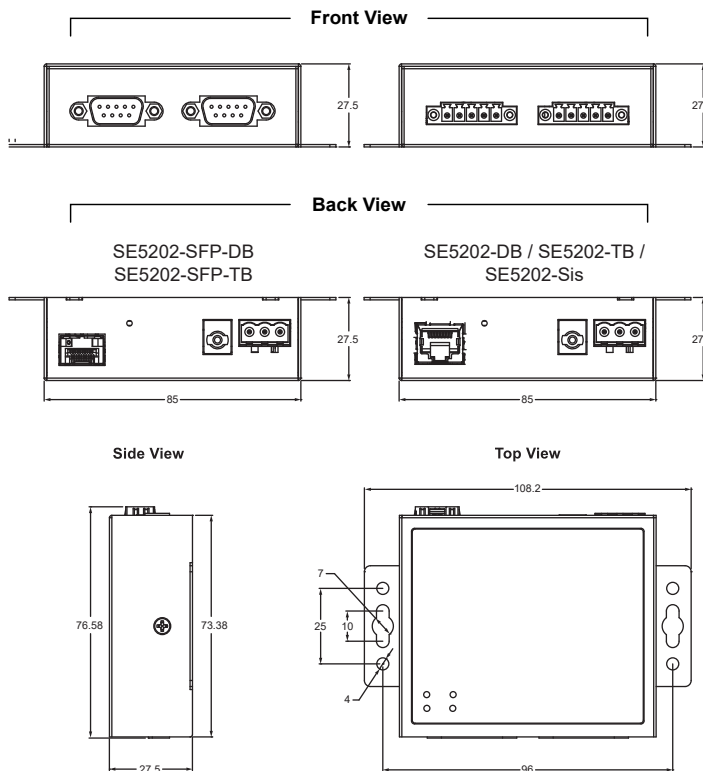

※ The Din Rail Kit illustrated in this Document is for reference only and is not included in the package

Warranty Policy

Warranty Conditions

Products supplied by Atop Technologies are covered in this warranty for sub-standard performance or defective workmanship. The warranty is not, however, extended to goods damaged in the following circumstances:

- (a) Excessive forces or impacts
- (b) War or an Act of God: wind storm, fire, flood, electric shock, earthquake
- (c) Use of unqualified power supply, connectors, or unauthorized parts/kits
- (d) Replacement with unauthorized parts

RMA and Shipping Costs Reimbursement

Customers shall always obtain an authorized "RMA" number from Atop before shipping the goods to be repaired to Atop. When in normal use, a sold product shall be replaced with a new one within 3 months after purchase. The shipping cost from the customer to Atop will be reimbursed by Atop.

After 3 months and still within the warranty period, it is up to Atop whether to replace the unit with a new one; normally, as long as a product is under warranty, all parts and labor are free of charge to the customers.

After the warranty period, the customer shall cover the cost for parts and labor. Three months after purchase, the shipping cost from the customer to Atop will not be reimbursed, but the shipping cost from Atop to the customer will be paid by Atop.

Limited Liability

Atop shall not be held responsible for any consequential losses from using Atop's product.

Warranty Period

Product Categories	Warranty	Product Categories	Warranty	
Ethernet Switches	5 Years	DIN-Rail Power Supplies	3 Years	
Wireless		Antennas	1 Year	
Serial Device Servers				Power Adaptors
Modbus Gateways				Other Accessories
Media Converters				
Embedded Device Servers				

The warranty certification will not be effective until an authorized stamp issued by Atop's overseas agents.

Purchase Date: / / (yyyy/mm/dd)

Serial Number



Atop Customer Services and Supports

- Please contact your local dealers or Atop Technical Support Center at the following numbers.
+ 886-3-550-8137 (Atop Taiwan)
+ 86-21-6495-6232 (Atop China)
- Please report the defected problems via Atop's Web site or E-mail account
Web Site : www.atop.com.tw, e-mail : service@atop.com.tw
Web Site : www.atop.com.cn, e-mail : service@atop.com.cn

— Any changes to this material will be announced on Atop website. —