



2023-2024

**INDUSTRIAL
NETWORKING
SOLUTIONS**

Contents

Industrial Networking

Introduction	04
ATOP Brand Mission	05
Reliability	05
Harsh Environments	07
Electromagnetic Compatibility	07
ATOP Cyber Security Solution	08
Performance & Responsiveness	09

Entry-Level Switch

Unmanaged Entry-Level Switch	11
Slim Unmanaged Switch	13
Slim Lite-Managed Switch	13
Lite-managed Smart Secure Switch	14
Deployment Scenario	14

Harsh Environment Networking

High-EMC Unmanaged Switch	16
Harsh Environment Unmanaged Switch with 24V PoE Booster	16
Lite-Managed DIN-Rail Switch with 24V PoE Booster	17
Lite-Managed DIN-Rail Switch with NAT functions	17
Industrial Layer2 Managed PoE Switch	18
Slim type full managed L2 switch with PoE++	21
Layer-3 Managed Switch	22
Layer-3 Managed DIN-Rail Switch	22
Managed Rack-Mount Switch	25
Modular Concept	26
Switch Core Platforms	26
Modules	27

Industry-specific Networking

Industry Ethernet for Substation Automation and Smart Grids	28
Our Regulatory Approvals	29
IEC 61850-3 Managed DIN-Rail Switch	30
IEC 61850-3 Rack-Mount Gigabit Managed Switch	30
PTP Grandmaster Precision Timing	33
Railway Networking: EN50155 and EN50121-4	34
EN50155 Railway Unmanaged Switch	36
EN50155 Managed Switch	37
Marine	39
Oil & Gas	39
Network Management Utility	40

Industrial Wireless

Industrial Wi-Fi Mesh	43
-----------------------	----

Interoperability

Industrial IoT Remote I/O	45
---------------------------	----

Serial Device Server

Entry-Level Serial Device Server	46
Wireless/Cellular Serial Device Server	47
Advanced Serial Device Server	49
Serial Console Server	50
IEC61850-3 Substation-Specific Serial Device Server	51
EN50155 Railway Specific Serial Device Server	52
SDK-Included Serial Device Servers	52

Protocol & Modbus Gateways

Protocol Gateways	53
Modbus Gateways	54

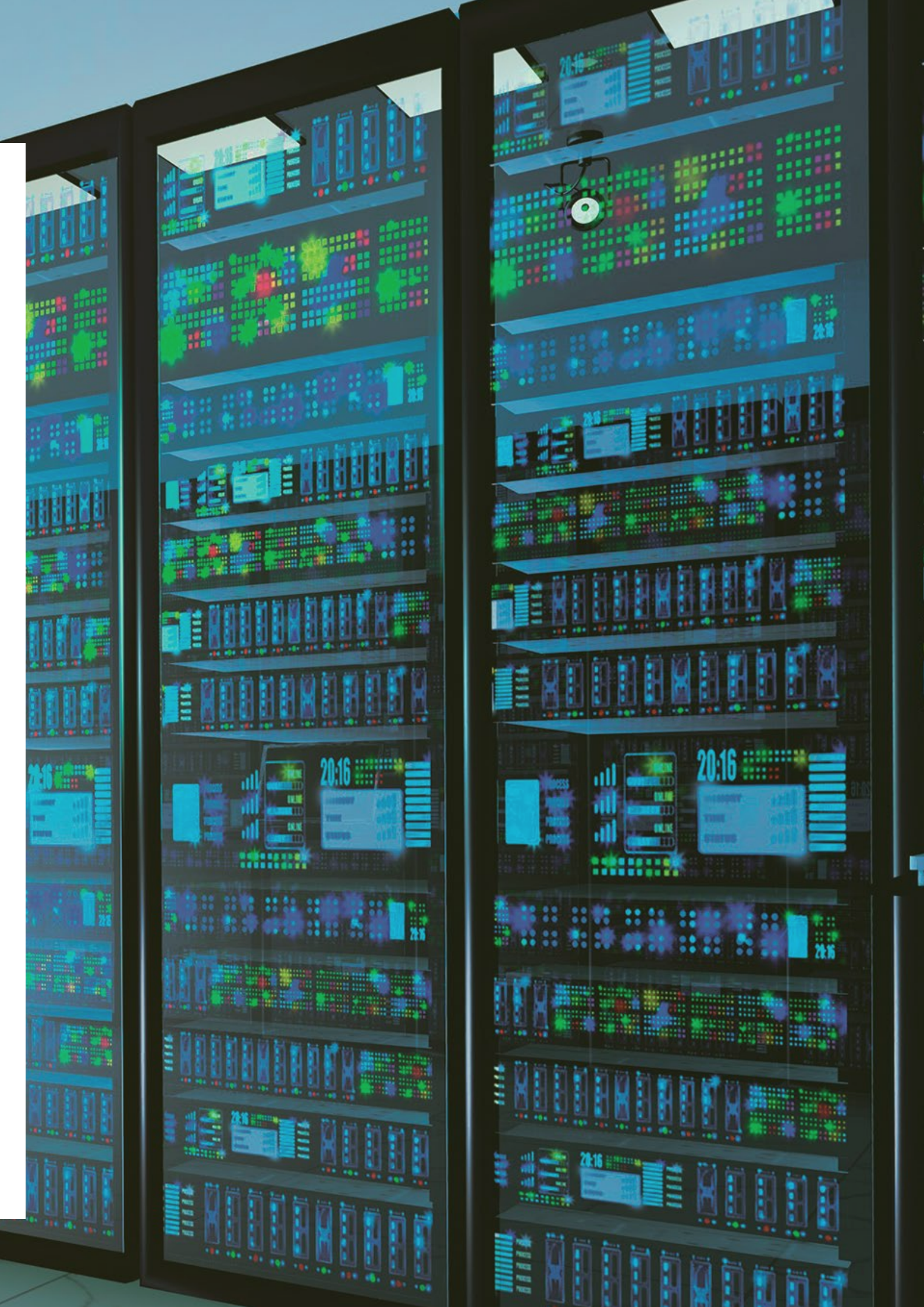

Industrial Networking



Introduction

Championed as the Fourth Industrial Revolution, Industry 4.0 has emerged as an imperative to put industries at the forefront of new opportunities. With the dawn of Smart Factory, a new intelligent and connected manufacturing has become the new flavour of this era. Are you enabling smart automation connectivity on the factory floor to enhance productivity, reduce expense, minimize system downtime and improve process matrix... even under the harshest and most challenging work conditions?

At the juncture of this critical transformational industrial shift - are you ready to respond to individual demand by enabling connected manufacturing? Are you equipped to converge advanced robotics, big data Analytics with industrial connectivity to enable faster, more flexible, and more efficient processes to produce and enable higher-quality goods and services at reduced costs?

At ATOP, we solve our clients' toughest industrial networking and computing problems through our slew of industry ready and customized product lines. With expertise across sectors like Industrial Automation, Power Substations, Smart Grid, Railways, Industrial Networking, IT Services, Oil and Gas, we deliver transformational outcomes for a demanding new industrial manufacturing world.

With over three decades of experience, ATOP has built a name of repute in developing and manufacturing a range of new age industrial networking and computing products to suit your application mandate, and within your budget. Our wide array of product categories encompasses industrial Ethernet switches, industrial wireless routers and APs, serial device servers, protocol gateways, media converters, industrial computing, precision timing clocks, and more.



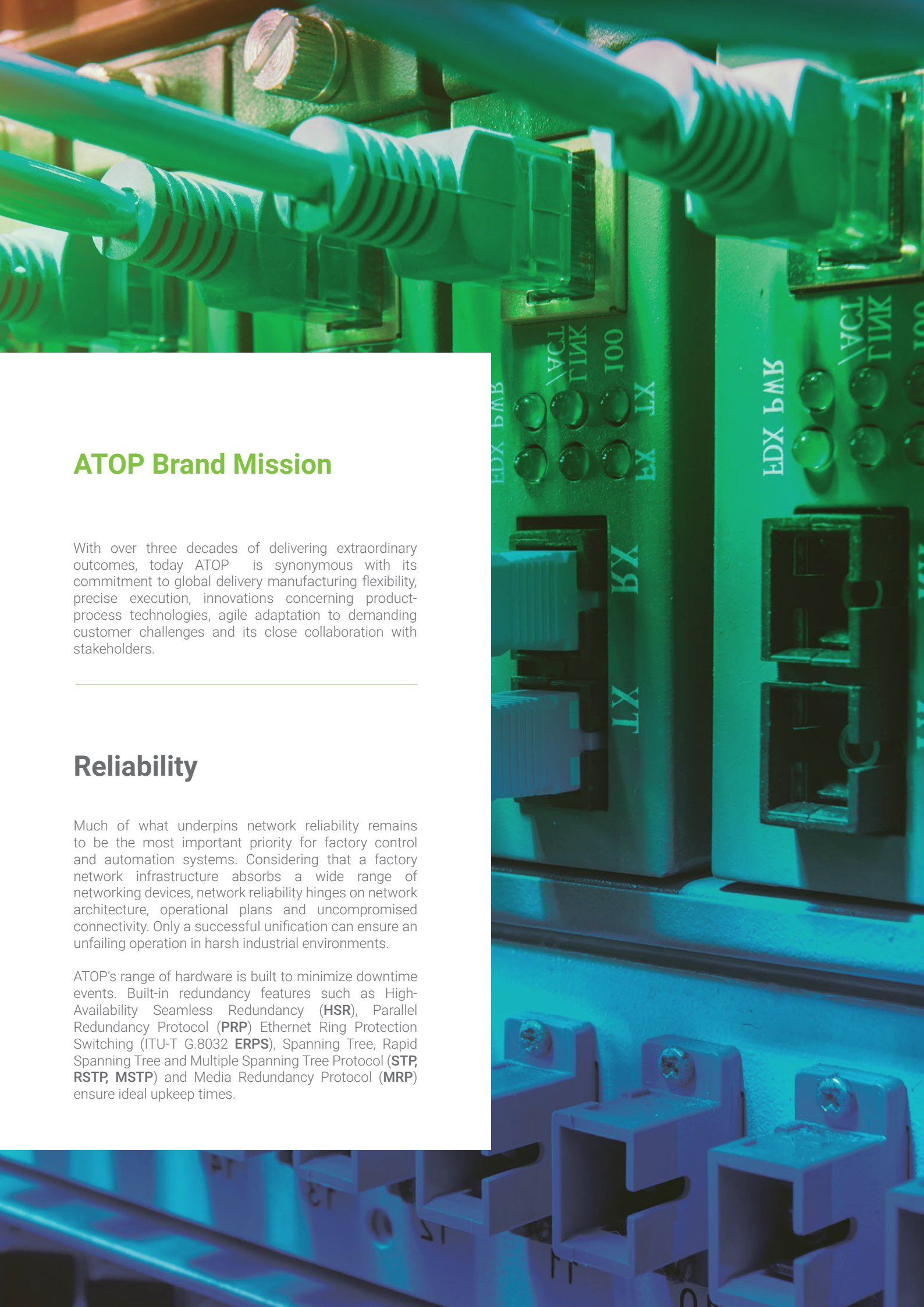

ATOP Brand Mission

With over three decades of delivering extraordinary outcomes, today ATOP is synonymous with its commitment to global delivery manufacturing flexibility, precise execution, innovations concerning product-process technologies, agile adaptation to demanding customer challenges and its close collaboration with stakeholders.

Reliability

Much of what underpins network reliability remains to be the most important priority for factory control and automation systems. Considering that a factory network infrastructure absorbs a wide range of networking devices, network reliability hinges on network architecture, operational plans and uncompromised connectivity. Only a successful unification can ensure an unflinching operation in harsh industrial environments.

ATOP's range of hardware is built to minimize downtime events. Built-in redundancy features such as High-Availability Seamless Redundancy (**HSR**), Parallel Redundancy Protocol (**PRP**) Ethernet Ring Protection Switching (ITU-T G.8032 **ERPS**), Spanning Tree, Rapid Spanning Tree and Multiple Spanning Tree Protocol (**STP**, **RSTP**, **MSTP**) and Media Redundancy Protocol (**MRP**) ensure ideal upkeep times.

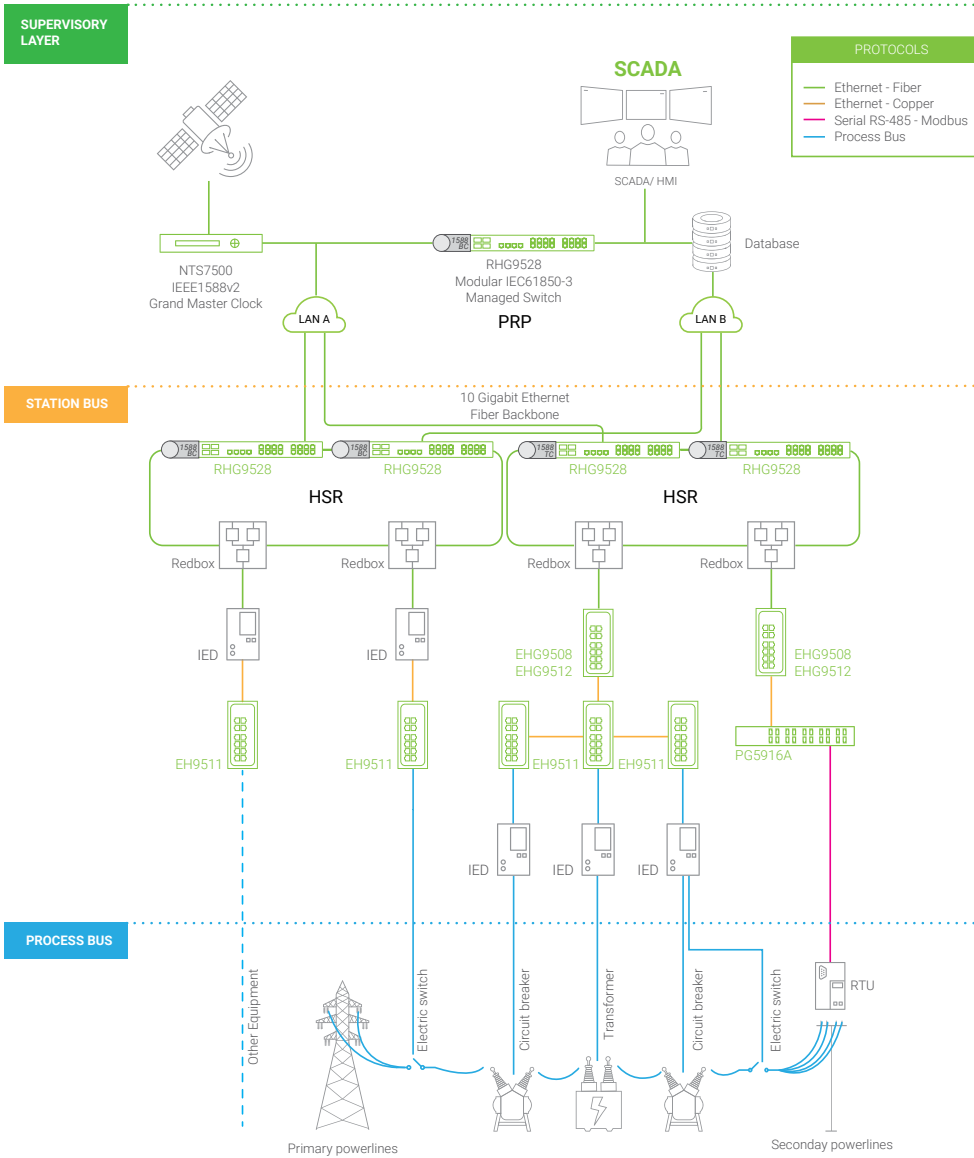

FEATURED PRODUCTS

NEW



EH9711: 11-Port Fast Ethernet IEC 61850-3 Industrial Layer2 Managed Switch

- 8x 10/100 Mbps RJ-45 ports and 3x Gb uplink SFP slots
- IEC 61850-3 & IEEE1613 compliance
- Secure industrial network design based on IEC 62443
- Network redundancy protocols: ITU-T G.8032 ERPS, STP, RSTP, and MRP Master/Client
- IEEE 1588 power profile specific parameters with C37.238 & IEC 61850-9-3



EHG9508/12, EHG9608/12: 8/12-Port GbE IEC 61850-3 Industrial Layer2/3 Managed Switch

- Up to 8x 10/100/1000 Mbps RJ-45 ports and 4x Gb uplink SFP slots
- IEC 61850-3 & IEEE1613 compliance
- Comply with UL/CUL/IEC(CB) 61010-2-201, CE, and FCC standards
- Precision time synchronization with IEEE1588v2 P2P/E2E TC with delay within 50ns, Network redundancy protocols: ITU-T G.8032 ERPS, STP, RSTP, and MRP Client



RHG9528/RHG9628: 10Gb Modular Layer2/3 Managed IEC 61850-3 Industrial Rackmount Switch

- 4x 10/1 Gb uplink SFP slots with 3x module slots of up to 8x Gb RJ-45/SFP ports each
- Available modules: 4/8x 10/100/1000 Mbps RJ-45 ports, 4/8x 100/1000Mbps SFP slots
- IEC 61850-3 & IEEE1613 compliance
- IEEE 1588 power profile specific parameters with C37.238 & IEC 61850-9-3; Precision time synchronization with IEEE1588v2 P2P/E2E TC with delay within 50ns; Network redundancy protocols: ITU-T G.8032 ERPS, STP, RSTP, and MRP Master/Client
- Support HSR & PRP (IEC 62439-3 Clause 4 & 5)
- Operating Temperature: -40°C to +75°C



Harsh Environments

From blast furnaces to operating in sub zero-degree environments, ATOP's line of hardware is designed to withstand the rigors of harsh operational conditions. With an ability to endure **operations temperature that ranges between -40°C to +85°C**, our hardware uses high quality industrial grade materials to guarantee a long Mean Time Between Failures (MTBF).

Thanks to **fanless design**, our devices help you reduce the number of moving parts, save space, reduce breakdowns and failures, thereby prolonging the operational lifetime of your investment.

Electromagnetic Interference and Susceptibility

High-voltages and electromagnetic interferences in factories can be fatal and quickly compromise system reliability if installed devices are not properly shielded and isolated from electromagnetic discharges.

Without proper precautions, equipment failures occur – for instance, a 2,000-Volt surge applied to a power supply unit can cause severe system damage. **Devices should be designed to ensure no interference with surrounding equipment**, as their own radiated emissions can generate noise and interference. Severe **electromagnetic interference can cause high temperature variations, server and network switch disablement, data communication interruption and in the worst cases even breakdowns.**

ATOP's hardware, engineered to offer a higher level of protection, conforms with high Electromagnetic Susceptibility (EMS) and Electromagnetic Interference (EMI) standards. And these are in addition to conforming with Level 3 and Level 4 Electromagnetic Compatibility (EMC), which makes ATOP's hardware compliant with the strictest regulations for susceptibility and interference – such as UL61010-2-201, UL60950, UL62368 and EN61000-6-2 and EN61000-6-4 with selected hardware specifically designed for even harsher applications, complying with IEC61850-3 and EN50155.

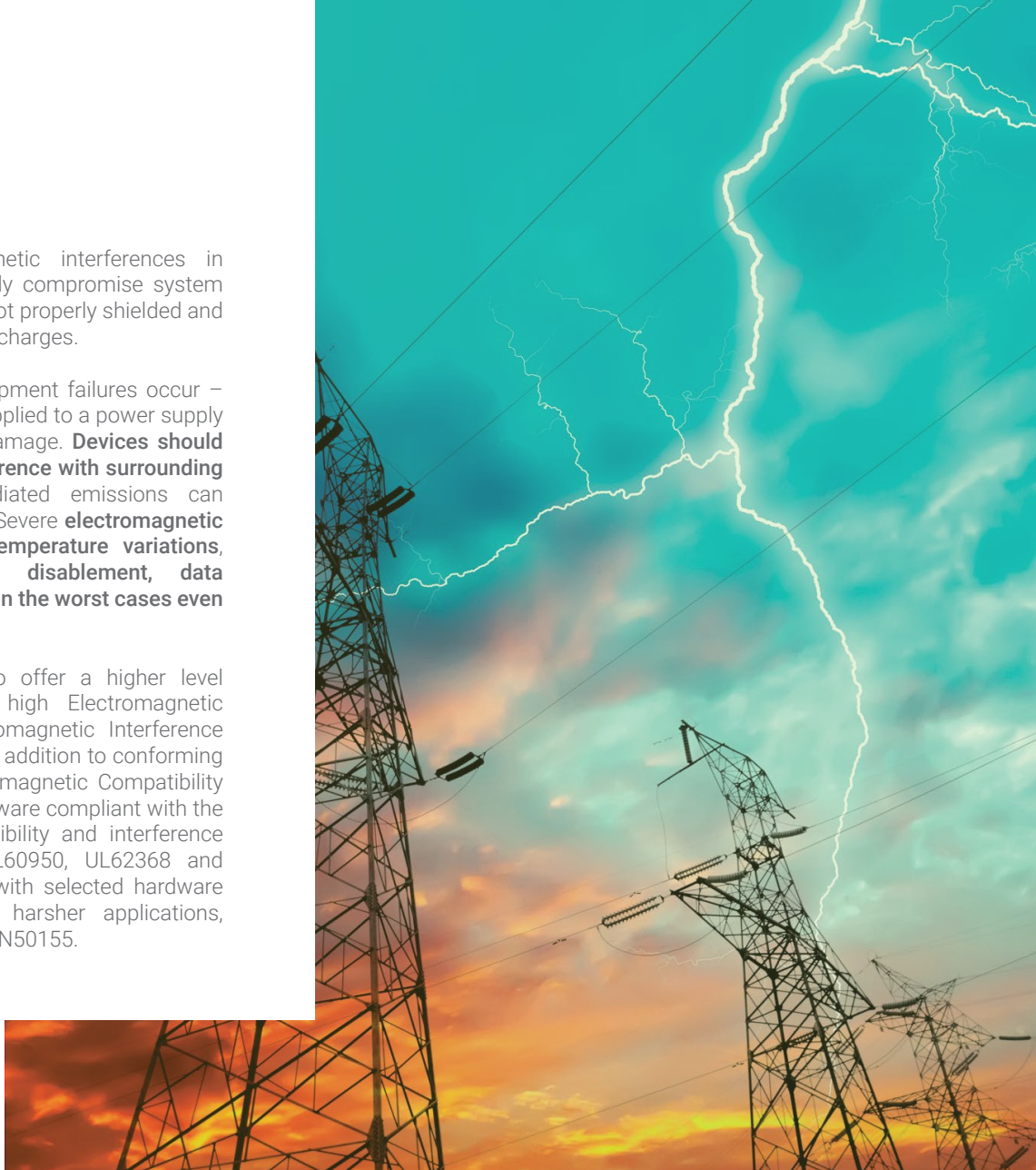

Cybersecurity

With explosive growth of devices and data, within the context of digital transformation, converging networks bring with them lethal security challenges that can have extensive effects across Industry 4.0 driven operations. As increased digital proliferation pose more risks, more points of entry lay susceptible to various sophisticated threats and malicious activities.

To adequately address this, ATOP has launched secure, vigilant and resilient hardware solutions for seamless and cost-effective security and encryption: **MACsec** for security over LANs; and software-based **IPsec**, **OpenVPN** and **PPTP** for security over WANs and the Internet.

To confront the increasing number of cyber incidents, system integrators have to prove that their network devices meet the technical requirements defined in the relevant guidelines of the IEC 62443 standard. The solutions must include enhanced component-level security and a mechanism to manage the security level of devices.

ATOP has incorporated compliance with IEC 62443 in all developments, receiving IEC 62443-4-1 and ISASecure Security Development Lifecycle Assurance (SDLA) certification in 2022. Further certifications are also in progress to help guarantee the highest security possible for your network.

ATOP is a pioneer in the security of network devices. In our continuous endeavour to bring the very best we have introduced a whole new range of products. This includes, Managed L2 and L3 switches (for advanced networks that demand routing between different VLANs and IP based routing). Our cost-effective smart and secure switches offer PoE connectivity and superior performance in harsh environments. With the 128-bit encryption managed through hardware, we provide a seamless experience and unprecedented performance.

ATOP's VPN Gateways provide embedded security measures, through VPNs using IPsec encryption, so that all data going in and out of devices can be properly protected from potential attacks. In addition to data encryption through the tunnel, gateways also provide a network-based firewall. With the firewall protection, equipments are easily able to monitor incoming and outgoing network traffics based on predetermined security rules.

Besides advanced encryption and firewalls, a data diode can further protect critical systems from the inside out by ensuring that only approved traffic can pass through in a defined direction. Learn more about this technology from our family member and close partner, BlackBear Cyber Security.



blackbear-ics.com

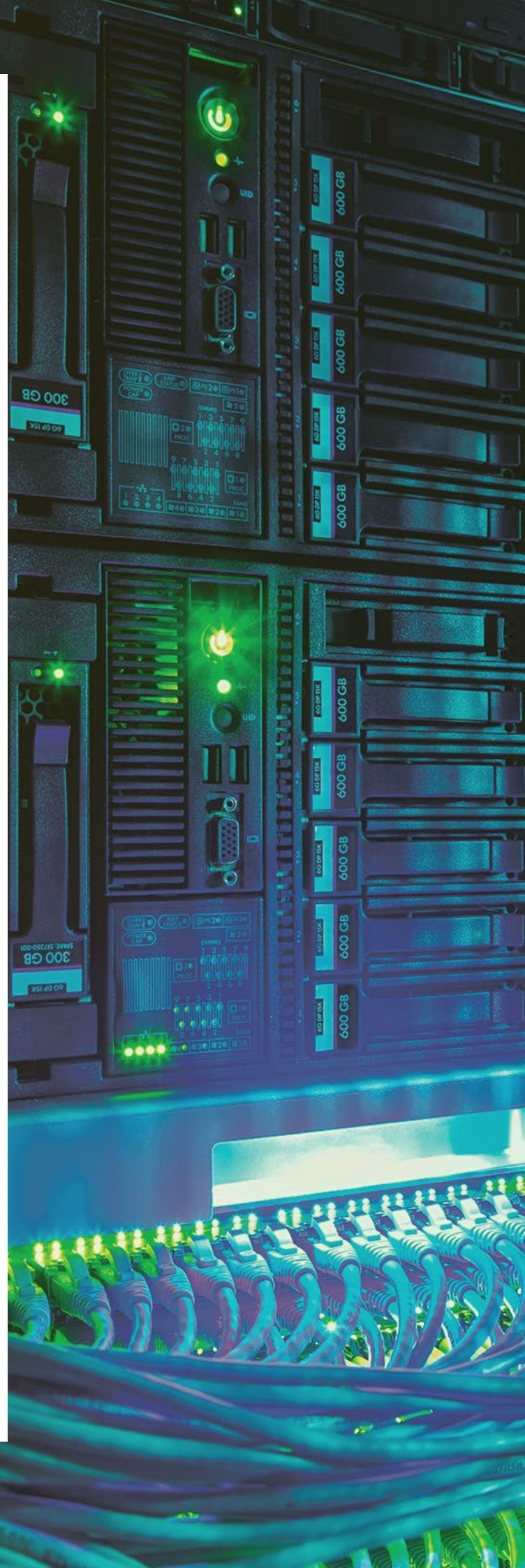

Performance and Responsiveness

Integrating new and emerging network hardware with legacy network equipment can often be difficult but indispensable to the churn of tomorrow's smart manufacturing. New technologies not only offer much wider bandwidths but also demand stricter performance requirements. The integration may result in slow process acceleration while exploring and consolidating performance discrepancies, such as differences in speed or data throughput.

ATOP being a 30-year-old company is in synch with the leaps of innovation and retrofitting new into legacy to enable several specific smart capabilities and outcomes. For example, our new network devices can autonomously poll data from legacy network devices and store them in an internal memory. A master device running on a newer protocol or higher physical layer can then request the updates at a later point. This helps to reduce bottlenecks and enhance system performance.

Deployment Scenario

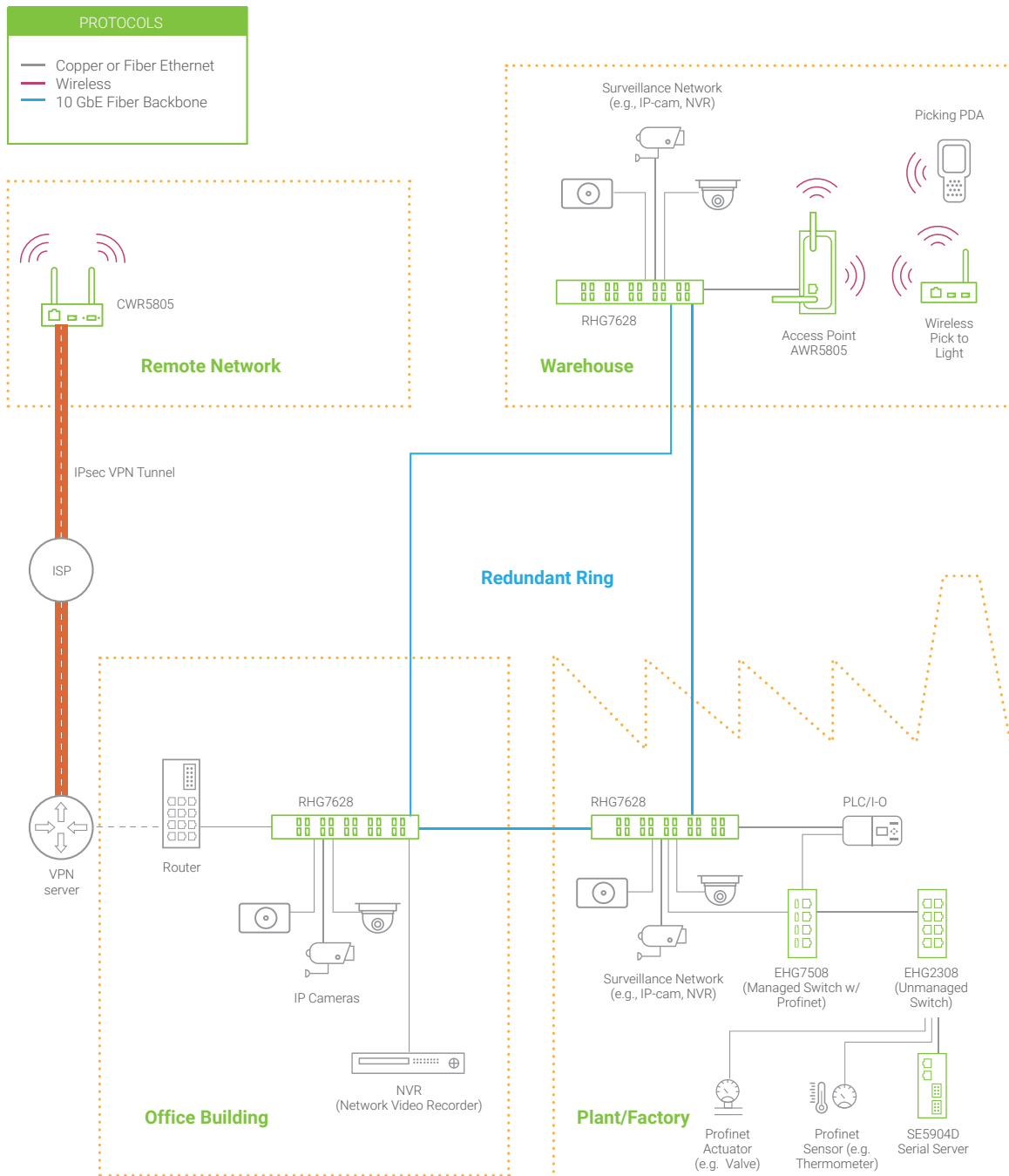

Related Product



RHG7628 - 10/1 GbE Modular Layer3 Managed PoE Rackmount Switch

- Modular architecture for up to 24x GbE ports and 4x 1 Gb or 10 Gb uplink SFP slots.
- Flexible configuration allows PoE ports, general RJ-45/SFP ports, and RJ-45/SFP ports with MAC security to be equipped on the same device.
- Up to 24x PoE/PoE+ ports following IEEE 802.3 af/at standard, with maximum power budget of 720 Watts.
- Network redundancy protocols: ITU-T G.8032 ERPS, STP, RSTP, MSTP, and MRP Master/Client
- Precision time synchronization with IEEE1588v2 P2P/E2E TC with delay within 50ns
- Comply with CE, FCC, and UL standards
- Operating temperature: -40°C to +75°C



EHG7512 - 12-Port GbE Layer2 Managed PoE Switch with 10Gb Uplink SFP

- 4x 10Gb uplink SFP slots with up to 8x GbE RJ-45 ports (optional PoE) and 4x Gb SFP slots
- Up to 8 802.3af 802.3at PoE/PoE+ ports allowing 240 W maximum PoE power Budget
- Network redundancy protocols: ITU-T G.8032 ERPS, STP, RSTP, MSTP, and MRP Master/Client
- Redundant power input of 12-57 VDC (non-PoE model); 45-57 VDC (PoE); 51-57 VDC (PoE+)
- Dual relay output w/ current carrying capacity of 1 A @ 24 VDC
- Comply with CE, FCC, and UL standards
- Operating temperature: -20°C to +70°C



EH3305 - Slim 5-Port Fast Ethernet Unmanaged Switch

- 5x 10/100 Mbps RJ-45 ports
- Support IEEE 802.1q VLAN tagging and IEEE 802.1p CoS (Class of Service)
- Comply with CE, FCC, and UL standards
- Redundant power input of 12-48 VDC
- Operating Temperature: -40°C to +70°C



CWR5805 - Industrial 5G/LTE Din-Rail 11ac Wi-Fi Router/Gateway

- 5G/LTE WAN connection
- Dual-SIM for redundancy
- 5x 10/100/1000 Mbps RJ-45 ports, including 1x for WAN and 4x for LAN
- 1st, 2.4GHz IEEE 802.11 b/g/n; 5GHz IEEE 802.11 a/n/ac. 2nd, 2x2 MU-MIMO
- Wi-Fi Mesh for seamless roaming
- OpenVPN/IPsec tunnel for secure data transmission



AWR5805 - Industrial 11ac Wi-Fi Din-Rail Router

- 5x 10/100/1000 Mbps RJ-45 ports, including 1x for WAN and 4x for LAN
- 1st, 2.4GHz IEEE 802.11 b/g/n; 5GHz IEEE 802.11 a/n/ac. 2nd, 2x2 MU-MIMO
- Wi-Fi Mesh for seamless roaming
- Open VPN/IPsec tunnel for secure data transmission
- Operating Temperature: -40°C to +75°C



Entry-Level Switch

Entry-Level Unmanaged Switch

ATOP's entry-level unmanaged switches offer a reliable, robust, and cost-effective solution for simple network topologies.

Besides IP30 protection rating, all entry-level unmanaged ATOP switches are industrial EMC-certified with EN61000-6-4 and EN61000-6-2 regulations. With DIN-Rail mountable housing in either aluminum, steel, or plastic material, ATOP switches are rugged enough to suit different environments and budgets. They can operate in temperature ranging from -10°C to 70°C (models with plastic housing, within range from 0°C to 60°C). For enhanced safety and backup, redundant DC power input is available on every entry-level model.

ATOP switches are featured with 4x to 16x Fast Ethernet or Gigabit Ethernet ports, and PoE is supported on PoE models. For Fiber requirements, models equipped with single/multi-mode Fiber uplinks are available. No configuration is required for unmanaged switches, and specific models support prioritization for Profinet packets via IEEE 802.1p.



Unmanaged / Fast Ethernet / DIN-Rail Mount / Plastic Housing



Model	Description	10/100 Mbps RJ-45 Port	Fiber Port	Housing	
	EH2005-Fm	5-Port FE Unmanaged Switch with Fiber Optics	4	1x Multi-mode ST connector Max. Transmit Distance 2 Km	IP30 Plastic
	EH2005-Fs	5-Port FE Unmanaged Switch with Fiber Optics	4	1x Single-mode SC connector Max. Transmit Distance 20 Km	IP30 Plastic
	EH2006	6-Port FE Unmanaged Switch	6	-	IP30 Plastic
	EH2008	8-Port FE Unmanaged Switch	8	-	IP30 Plastic

Unmanaged / Fast Ethernet / DIN-Rail Mount / Metal Housing



Model	Description	10/100 Mbps RJ-45 Port	Gigabit RJ-45 Port	Fiber Port	Housing	
	EH2305-1Fm	5-Port FE Unmanaged Switch with Fiber Optics	4	-	1x Multi-mode ST connector Max. Transmit Distance 2 Km	IP30 Metal
	EH2305-1Fm	5-Port FE Unmanaged Switch with Fiber Optics	4	-	1x Single-mode SC connector Max. Transmit Distance 20 Km	IP30 Metal
	EH2306	6-Port FE Unmanaged Switch	6	-	-	IP30 Metal

Unmanaged / Fast Ethernet / DIN-Rail Mount / Metal Housing



Model	Description	10/100 Mbps RJ-45 Port	Gigabit RJ-45 Port	Fiber Port	Housing	Notes
	EH2308	8-Port FE Unmanaged Switch	8	-	-	IP30 Metal Profinet CC-A
	EH2308 (E-mark)	8-Port FE Unmanaged Switch	8	-	-	IP30 Metal Profinet CC-A
	EH2304-PR	4-Port FE Unmanaged Switch	4	-	-	IP30 Metal, Slim Profinet CC-A, Profinet connectors
	EH2308-PR	8-Port FE Unmanaged	8	-	-	IP30 Metal Profinet CC-A, Profinet connectors
	EH2316-2G	16-Port FE Unmanaged Switch with 2x Gb Uplinks	14	2	-	IP30 Metal Profinet CC-A

Unmanaged / Gb Ethernet / DIN-Rail Mount / Metal & Plastic Housing



Model	Description	10/100/1000 Mbps RJ-45 Port	Housing	Notes
	EHG2008	8-Port Gb Unmanaged Switch	8	IP40 Plastic Profinet packet prioritization Operating Temp.: 0°C to +60°C
	EHG2308	8-Port Gb Unmanaged Switch	8	IP30 Metal Profinet packet prioritization

Slim Unmanaged Switch

EHG3005, EH3305, EH3005 Series are cost-effective industrial switches, compliant with CE, FCC, and UL standards. Deployments in narrow and hazardous locations are made easy with the compact and robust housing for all of these slim switches, reducing cost and time consumption.

For harsher industrial environments, EH3305 is suggested with its tolerance of operating temperature from -40°C to 70°C.

Unmanaged / Gb Ethernet / DIN-Rail Mount / Metal & Plastic Housing



Model	Description	10/100 Mbps RJ-45 Port	10/100/1000 Mbps RJ-45 Port	Housing	Notes	
	EH3005	5-Port FE Unmanaged Switch	5	-	IP30 Plastic, Slim	Profinet CC-A
	EH3305	5-Port FE Unmanaged Switch	5	-	IP30 Metal, Slim	Profinet CC-A
	EHG3005	5-Port GbE Unmanaged Switch	-	5	IP30 Plastic, Slim	Profinet CC-A Operating Temp.: 0°C to +60°C
	EHG3305	5-Port GbE Unmanaged Switch	-	5	IP30 Metal, Slim	Profinet CC-A

Slim Lite-Managed Switch

EH3408 series are Fast-Ethernet lite-managed switches for supreme spatial and cost efficiency. Deployment and replacement-friendly, it offers zero-touch configuration backup/restore through USB or Micro-SD, redundancy and diagnostics through SNMP, RSTP, VLAN, Logging, LLDP, and secure IEC62443 function requirements compliance.

Lite-managed / Fast Ethernet / Slim-type / DIN-Rail Mount / Metal Housing

NEW





Model	Description	10/100 Mbps RJ-45 Port	Housing	Notes	
	EH3408ls	8-Port Fast Ethernet Lite-Managed Switch	8	IP30 Plastic, Slim	-
	EH3408lu	8-Port Fast Ethernet Lite-Managed Switch	8	IP30 Metal, Slim	-
	EH3408s	8-Port Fast Ethernet Lite-Managed Switch	8	IP30 Plastic, Slim	0°C to +60°C (+32°F to +140°F)
	EH3408u	8-Port Fast Ethernet Lite-Managed Switch	8	IP30 Metal, Slim	0°C to +60°C (+32°F to +140°F)

Lite-managed Smart Secure Switch

ATOP's lite-managed smart-secure switch is a cost-effective solution to provide the network with security and low latency without any configuration required. It is equipped with 6x 10/100/1000 RJ-45 ports and 2x 10/100/1000 secured RJ-45 ports or SFP slots. To provide network security, the CPU of a smart-secure switch does key negotiation with LAN hosts automatically via a PSK (Pre-Shared Key). Manual configuration is not required.

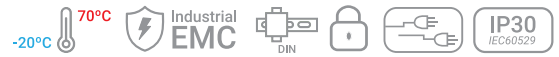
Lite-managed / Smart Secure / Gb Ethernet / DIN-Rail Mount / Metal Housing



Model	Description	10/100/1000 Mbps RJ-45 Port	Gigabit SFP Slot	Housing	Notes
 EHG2408	8-Port Gb Lite-Managed Switch with 2x MACsec RJ-45 Ports	6x General + 2x MACsec capable	-	IP30 Metal	Prioritizes Profinet packets
EHG2408-2SFP	8-Port Gb Lite-Managed Switch with 2x MACsec SFP Slots	6x General	2x MACsec capable	IP30 Metal	Prioritizes Profinet packets

Deployment Scenario

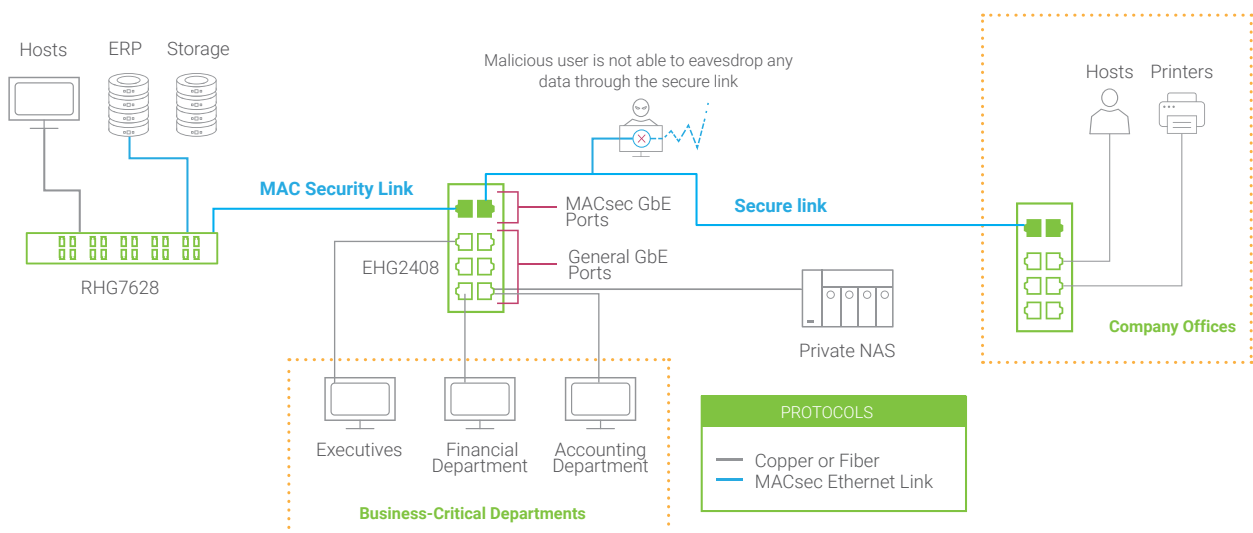

Related Product

RHG7628 - 10/1 GbE Modular Layer3 Managed PoE Rackmount Switch



- Modular architecture for up to 24x GbE ports and 4x 1 Gb or 10 Gb uplink SFP slots
- Flexible configuration allows PoE ports, general RJ-45/SFP ports, and RJ-45/SFP ports with MAC security to be equipped on the same device.
- Up to 24x PoE/PoE+ports following IEEE 802.3 af/at standard, with maximum power budget of 720 Watts.
- Network redundancy protocols: ITU-T G.8032 ERPS, STP, RSTP, MSTP, and MRP Master/Client
- Precision time synchronization with IEEE1588v2 P2P/E2E TC with delay within 50ns
- Comply with CE, FCC, and UL standards
- Operating temperature: -40°C to +75°C

Harsh Environment Networking

ATOP's extensive and advanced product line offers hundreds of possible options to meet countless scenarios. For networks in mission-critical environments, the harsh-environment-series is able to provide flexibility and high security.

From PoE injectors all the way up to Layer3 switches, ATOP offers networking devices equipped with up to 28x Fast Ethernet/GbE/10GbE ports, and PoE/PoE+ supported on PoE models.

The harsh-environment series are able to operate in temperatures from -20°C to 70°C, or even wider for MIL-STD shock and vibration certified products.

Some of the devices are equipped with relay output and redundant power input for security issue, while some feature Profinet packet prioritization.

ATOP's Harsh-Environment Unmanaged Switches provide high EMC protection, ruggedness for the most demanding applications and easy plug-and-play installation. Our Unmanaged switches have a wide-range operation temperature. Selected models of both PoE and non-PoE versions are Railway certified and Atex or UL Cl. 1 Div. 2 certified for Oil and Gas applications.

Also, do more with your PoE through ATOP. The EHG6400 Family supports **PoE voltage booster**, providing up to **60W of PoE power with just 12V** input on up to 8 Gigabit ports, or up to **120 Watts of power with 24VDC input and over.**

ATOP's Lite-Managed Gigabit Switches provide added redundancy, exceptional performance, manageability and reliability, maximizing value for money. EHG6500 Family enables an 8 or 10-port Gigabit switch to act smartly with visibility and control, prioritizing traffic, managing VLAN, policies and providing smart redundancy in mission-critical applications while keeping costs under control.

ATOP's range of ruggedized Managed Switches provide advanced network management to maximize network performance and minimize downtimes. Our Managed Switches use ERPS, RSTP, STP, MSTP and MRP (Client and Manager) to minimize such downtimes with information that helps preventing downtime to troubleshoot. With highest level of security and precision control, they can manage networks efficiently through embedded SNMP, QoS, VLAN, and they can provide Precision time synchronization with support for IEEE 1588v2 PTP.

ATOP Layer-3 Switches provide an ideal solution for scaling up industrial networks. Highly reliable, fault tolerant, all certified with EN50155 and EN50121-4, they support IPv4 Static Routing, Dynamic Routing RIPv1/v2, OSPFv2, BGPv4, and multicast protocols such as PIM-DM, PIM-SM, DVMRP. And for high level network security, MACsec Protocol can be used.



High-EMC Unmanaged Switch

Plug-and-play with Gigabit connectivity, ATOP's High-EMC unmanaged switch is designed for deployment in harsh and demanding industrial environments.

The key features of this series are the availability of 5 to 7 Gigabit Ethernet ports, embedded Power over Ethernet (PoE) on selected models, and a variety of port configurations – such as RJ-45 or SFP. And with UL Class 1 Division 2 Certification plus ATEX Zone 2 certification, this series is suitable for use in locations like mines – environments that have a high risk of explosion.

Unmanaged / Gb / PoE / DIN-Rail Mount / Metal Housing



Model	Description	10/100/1000 Mbps RJ-45 Port	Gigabit SFP Slot	Certification
	EHG7305	5-Port GbE Unmanaged ATEX Switch	5x non-PoE	-
	EHG7306-1SFP	6-Port GbE Unmanaged ATEX Switch including 1x Gb uplink SFP slot	5x non-PoE	1
	EHG7307-2SFP	7-Port GbE Unmanaged ATEX Switch including 2x Gb uplink SFP slots	5x non-PoE	2
	EHG7305-4PoE	5-Port Gb PoE Unmanaged ATEX Switch including 4x PoE RJ-45	4x PoE 1x non-PoE	-
	EHG7306-4PoE-1SFP	6-Port Gb PoE Unmanaged ATEX Switch including 4x PoE RJ-45 & 1x Gb uplink SFP slot	4x PoE 1x non-PoE	1
	EHG7307-4PoE-2SFP	7-Port Gb PoE Unmanaged ATEX Switch including 4x PoE RJ-45 & 2x Gb uplink SFP slots	4x PoE 1x non-PoE	2

Harsh Environment Unmanaged Switch with 24V PoE Booster

Take all advantages of Harsh Environment Switches, and add more. Available in 8 or 10-port versions, all Full-Gigabit, selected options allow you to provide PoE power to IP cameras and many more PD devices with a DC power input accepting 12-57V and thus relieving you the installation and cost of an expensive 48V power supply. EHG6400 Series combines a compact size, up to 120W PoE power budget, CE/FCC/UL and E-Mark certification for usage on board of vehicles.

Unmanaged / Gb / PoE / Booster / DIN-Rail Mount / Metal Housing



Model	Description	10/100/1000 Mbps RJ-45 Port	Gigabit SFP Slot	100/1000 Mbps SFP Slot	
	EHG6408	8-Port GbE Unmanaged Switch	8x non-PoE	-	
	EHG6410-2SFP	10-Port GbE Unmanaged Switch including 2x Gb SFP Slots	8x non-PoE	2	
	EHG6410-2SFP-D	10-Port GbE Unmanaged Switch including 2x dual-speed SFP Slots of 100/1000 Mbps	8x non-PoE	-	2
	EHG6408-4PoE-24V	8-Port GbE Unmanaged PoE Switch including 4x PoE RJ-45 and 12/24 VDC PoE Booster	4x PoE 4x non-PoE	-	-
	EHG6408-8PoE-24V	8-Port GbE Unmanaged PoE Switch including 8x PoE RJ-45 and 12/24 VDC PoE Booster	8x PoE	-	-
	EHG6410-4PoE-2SFP-24V	10-Port GbE Unmanaged PoE Switch including 2x Gb SFP Slots, 4x PoE RJ-45, and 12/24 VDC PoE Booster	4x PoE 4x non-PoE	2	-
	EHG6410-8PoE-2SFP-24V	10-Port GbE Unmanaged PoE Switch including 2x Gb SFP Slots, 8x PoE RJ-45, and 12/24 VDC PoE Booster	8x PoE	2	-
	EHG6410-4PoE-2SFP-D-24V	10-Port GbE Unmanaged PoE Switch including 2x dual-speed SFP Slots of 100/1000 Mbps, 4x PoE RJ-45, and 12/24 VDC PoE Booster	8x PoE	-	2
	EHG6410-8PoE-2SFP-D-24V	10-Port GbE Unmanaged PoE Switch including 2x dual-speed SFP Slots of 100/1000 Mbps, 8x PoE RJ-45, and 12/24 VDC PoE Booster	8x PoE	-	2

Lite-Managed DIN-Rail Switch with 24V PoE Booster

Combine the power of **harsh environments capability, compact size, PoE booster** to enable PoE power with just 12 or 24V power input, **Gigabit speed** and ATOP robustness **with lite-management capabilities**. EHG6500 Family can be easily set-up with a user-friendly **web interface** and is the right solution for **equipping your network of security, monitoring and redundancy** feature without the need to adapt a fully managed, more expensive switch that in smaller applications will not be exploited at its best. EHG65 supports:

Traffic Optimization

- QoS
- VLAN

Security and Monitoring

- HTTP/HTTPS
- SNMPv1/v2c/v3
- Modbus TCP

Redundancy

- 802.1D-2004 Rapid Spanning Tree Protocol

Lite-Managed / Gb / PoE / Booster / DIN-Rail Mount / Metal Housing



Model	Description	10/100/1000 Mbps RJ-45 Port	Gigabit SFP Slot	100/1000 Mbps SFP Slot
EHG6508	8-Port GbE Lite-Managed Switch	8x non-PoE	-	-
EHG6508-4PoE-24V	8-Port GbE Lite-Managed PoE Switch including 4x PoE RJ-45 and 12/24 VDC PoE Booster	4x PoE 4x non-PoE	-	-
EHG6508-8PoE-24V	8-Port GbE Lite-Managed PoE Switch including 8x PoE RJ-45 and 12/24 VDC PoE Booster	8x PoE	-	-
EHG6510-2SFP	10-Port GbE Lite-Managed Switch including 2x Gb SFP Slots	8x non-PoE	2	-
EHG6510-2SFP-D	10-Port GbE Lite-Managed Switch including 2x dual-speed SFP Slots of 100/1000 Mbps	8x non-PoE	-	2
EHG6510-4PoE-2SFP-24V	10-Port GbE Lite-Managed PoE Switch including 2x Gb SFP Slots, 4x PoE RJ-45, and 12/24 VDC PoE Booster	4x PoE 4x non-PoE	2	-
EHG6510-8PoE-2SFP-24V	10-Port GbE Lite-Managed PoE Switch including 2x Gb SFP Slots, 8x PoE RJ-45, and 12/24 VDC PoE Booster	8x PoE	2	-
EHG6510-8PoE-2SFP-D-24V	10-Port GbE Lite-Managed PoE Switch including 2x dual-speed SFP Slots of 100/1000 Mbps, 8x PoE RJ-45, and 12/24 VDC PoE Booster	8x PoE	-	2

Lite-Managed DIN-Rail Switch with NAT functions

Network Address Translation (NAT) allows mapping of a device's internet protocol (IP) address to another, reducing the overall number of globally valid IP addresses and simplifying setup procedures. The NAT Switch is a simple and effective solution for machine-builders or for infrastructure owners who require many identical subnets to be quickly interchangeable, maintained and protected at the same time, without modifying the machine network.

With up to 100Mbps NAT throughput, and freely configurable WAN/LAN ports, ATOP's 8- or 9-port NSG series makes your digitalization easy like no other.

Lite-Managed / Gb / PoE / Booster / DIN-Rail Mount / Metal Housing



Model	Description	10/100/1000 Mbps RJ-45 Port	100/1000 Mbps SFP Slot	NAT Throughput	Input Power
NSG3308	8-Port GbE Lite-Managed DIN-Rail Switch with NAT functions	8	-	100 Mbps	12-48VDC Dual Input
NSG3308-2SFP	8-Port GbE Lite-Managed DIN-Rail Switch with NAT functions, including 2x Gb SFP Slots	6	2	100 Mbps	12-48VDC Dual Input
NSG3309	9-Port GbE Lite-Managed DIN-Rail Switch with NAT functions	9	-	100 Mbps	12-48VDC Dual Input
NSG3309-2SFP	9-Port GbE Lite-Managed DIN-Rail Switch with NAT functions, including 2x Gb SFP Slots	7	2	100 Mbps	12-48VDC Dual Input

Industrial Layer2 Managed PoE Switch

ATOP's advanced Layer-2 Managed Switches for harsh environments provide rugged and reliable solutions for managing advanced networks. This series of switches offers a high degree of link redundancy, flow control, security (security features based on IEEE 62443) and configurability for your network. All models are designed to conform with the strictest Level 3 and 4 EMC compliance requirements. Our components guarantee high-performance, even on full load. ATOP Managed Switches ensure ideal upkeep times. Profinet CC-B v2.33 certified are the ideal option for Industrial Automation and Media Redundancy Protocol (MRP Master/Client).

High-EMC / L2 Managed / FE / PoE / DIN-Rail Mount / Metal Housing



Model	Description	10/100 Mbps RJ-45 Port	10/100/1000 Mbps RJ-45 Port	100/1000 Mbps SFP Slot	
	EH7506-2SFP	6-Port FE L2-Managed Switch including 2x Gb SFP Slots	4x non-PoE	-	2
	EH7506-4PoE-2SFP	6-Port FE L2-Managed PoE Switch including 4x PoE RJ-45 and 2x Gb SFP Slots	4x PoE	-	2
	EH7508-4G-4SFP	8-Port FE L2-Managed Switch including 4x uplink combos for 10/100/1000 Mbps RJ-45 or 100/1000 Mbps SFP Slots	4x non-PoE	(4)	(4)
	EH7508-4G-4PoE-4SFP	8-Port FE L2-Managed PoE Switch including 4x PoE RJ-45 and 4x uplink combos for 10/100/1000 Mbps RJ-45 or 100/1000 Mbps SFP Slots	4x PoE	(4)	(4)
	EH7512-4G-4SFP	12-Port FE L2-Managed Switch including 4x uplink combos for 10/100/1000 Mbps RJ-45 or 100/1000 Mbps SFP Slots	8x non-PoE	(4)	(4)
	EH7512-4G-4PoE-4SFP	12-Port FE L2-Managed PoE Switch including 4x PoE RJ-45 and 4x uplink combos for 10/100/1000 Mbps RJ-45 or 100/1000 Mbps SFP Slots	4x PoE 4x non-PoE	(4)	(4)
	EH7512-4G-8PoE-4SFP	12-Port FE L2-Managed PoE Switch including 8x PoE RJ-45 and 4x uplink combos for 10/100/1000 Mbps RJ-45 or 100/1000 Mbps SFP Slots	8x PoE	(4)	(4)
	EH7520-4G-4SFP	20-Port Managed Fast-Ethernet Switch with 4 Gigabit Combo uplink ports	16 x non-PoE	(4)	(4)
	EH7520-4G-4PoE-4SFP	20-Port Managed Fast-Ethernet Switch with 4 Gigabit Combo uplink ports and 4 PoE ports	4x PoE 12x non-PoE	(4)	(4)
	EH7520-4G-8PoE-4SFP	20-Port Managed Fast-Ethernet Switch with 4 Gigabit Combo uplink ports and 8 PoE ports	8x PoE 8x non-PoE	(4)	(4)

Note: Numbers in parenthesis are Combo ports.

High-EMC / L2 Managed / Gb / PoE / DIN-Rail Mount / Metal Housing



Model	Description	10/100/1000 Mbps RJ-45 Port	Gigabit SFP Slot	
	EHG7504	4-Port Gb L2-Managed Switch	4x non-PoE	-
	EHG7504-4PoE	4-Port Gb L2-Managed PoE Switch	4x PoE	-
	EHG7504-2SFP	4-Port Gb L2-Managed Switch including 2x Gb SFP Slots	2x non-PoE	2
	EHG7504-2PoE-2SFP	4-Port Gb L2-Managed PoE Switch including 2x PoE RJ-45 and 2x Gb SFP Slots	2x PoE	2
	EHG7504-4SFP	4-Port Gb L2-Managed Switch including 4x Gb SFP Slots	-	4



High-EMC / L2 Managed / Gb / PoE / DIN-Rail Mount / Metal Housing



Model	Description	10/100/1000 Mbps RJ-45 Port	Gigabit SFP Slot	
	EHG7508	8-Port Gb L2-Managed Switch	8x non-PoE	-
	EHG7508-4SFP	8-Port Gb L2-Managed Switch including 4x Gb SFP Slots	4x non-PoE	4
	EHG7508-4PoE-4SFP	8-Port Gb L2-Managed PoE Switch including 4x PoE RJ-45 and 4x Gb SFP Slots	4x PoE	4
	EHG7508-8PoE	8-Port Gb L2-Managed PoE Switch	8x PoE	-

High-EMC / L2 Managed / Gb / 10Gb SFP / PoE / DIN-Rail Mount / Metal Housing



Model	Description	10/100/1000 Mbps RJ-45 Port	100/1000 Mbps SFP Slot	1/10 Gb SFP Slot	
	EHG7512-410GSFP	12-Port GbE L2-Managed Switch including 4x 10 Gb Uplink SFP Slots	8x non-PoE	-	4
	EHG7512-4PoE-410GSFP	12-Port GbE L2-Managed Switch including 4x PoE RJ-45 and 4x dual-speed SFP Slots of 1/10 Gbps	4x PoE 4x non-PoE	-	4
	EHG7512-8PoE-410GSFP	12-Port GbE L2-Managed Switch including 8x PoE RJ-45 and 4x dual-speed SFP Slots of 1/10 Gbps	8x PoE	-	4
	EHG7512-4SFP-410GSFP	12-Port GbE L2-Managed Switch including 4x dual-speed SFP Slots of 100/1000 Mbps and 4x dual-speed SFP Slots of 1/10 Gbps	4x non-PoE	4	4
	EHG7512-4PoE-4SFP-410GSFP	12-Port GbE L2-Managed Switch including 4x PoE RJ-45, 4x dual-speed SFP Slots of 100/1000 Mbps, and 4x dual-speed SFP Slots of 1/10 Gbps	4x PoE	4	4
	EHG7516-410GSFP	16-Port GbE L2-Managed Switch including 4x 10 Gb Uplink SFP Slots	12x non-PoE	-	4
	EHG7516-4PoE-410GSFP	16-Port GbE L2-Managed Switch including 4x PoE RJ-45 and 4x dual-speed SFP Slots of 1/10 Gbps	4x PoE 8x non-PoE	-	4
	EHG7516-8PoE-410GSFP	16-Port GbE L2-Managed Switch including 8x PoE RJ-45 and 4x dual-speed SFP Slots of 1/10 Gbps	8x PoE 4x non-PoE	-	4
	EHG7516-4SFP-410GSFP	16-Port GbE L2-Managed Switch including 4x dual-speed SFP Slots of 100/1000 Mbps and 4x dual-speed SFP Slots of 1/10 Gbps	8x non-PoE	4	4
	EHG7516-4PoE-4SFP-410GSFP	16-Port GbE L2-Managed Switch including 4x PoE RJ-45, 4x dual-speed SFP Slots of 100/1000 Mbps, and 4x dual-speed SFP Slots of 1/10 Gbps	4x PoE 4x non-PoE	4	4
	EHG7516-8PoE-4SFP-410GSFP	16-Port Gb L2-Managed Switch including 8x PoE RJ-45, 4x dual-speed SFP Slots of 100/1000 Mbps, and 4x dual-speed SFP Slots of 1/10 Gbps	8x PoE	4	4
	EHG7516-8SFP-410GSFP	16-Port GbE L2-Managed Switch including 8x dual-speed SFP Slots of 100/1000 Mbps and 4x dual-speed SFP Slots of 1/10 Gbps	8x non-PoE	8	4
	EHG7516-4PoE-8SFP-410GSFP	16-Port GbE L2-Managed Switch including 4x PoE RJ-45, 8x dual-speed SFP Slots of 100/1000 Mbps, and 4x dual-speed SFP Slots of 1/10 Gbps	4x PoE	8	4
	EHG7516-12SFP-410GSFP	16-Port GbE L2-Managed Switch including 12x dual-speed SFP Slots of 100/1000 Mbps and 4x dual-speed SFP Slots of 1/10 Gbps	-	12	4

High-EMC / L2 Managed / Gb / 10Gb SFP / PoE / DIN-Rail Mount / Metal Housing (continue)



Model	Description	10/100/1000 Mbps RJ-45 Port	100/1000 Mbps SFP Slot	1/10 Gb SFP Slot
EHG7520-410GSFP	20-Port GbE L2-Managed Switch including 4x 10 Gb Uplink SFP Slots	16x non-PoE	-	4
EHG7520-4PoE-410GSFP	20-Port GbE L2-Managed Switch including 4x PoE RJ-45 and 4x dual-speed SFP Slots of 1/10 Gbps	4x PoE 12x non-PoE	-	4
EHG7520-8PoE-410GSFP	20-Port GbE L2-Managed Switch including 8x PoE RJ-45 and 4x dual-speed SFP Slots of 1/10 Gbps	8x PoE 8x non-PoE	-	4
EHG7520-4SFP-410GSFP	20-Port GbE L2-Managed Switch including 4x dual-speed SFP Slots of 100/1000 Mbps and 4x dual-speed SFP Slots of 1/10 Gbps	12x non-PoE	4	4
EHG7520-4PoE-4SFP-410GSFP	20-Port GbE L2-Managed Switch including 4x PoE RJ-45, 4x dual-speed SFP Slots of 100/1000 Mbps, and 4x dual-speed SFP Slots of 1/10 Gbps	4x PoE 8x non-PoE	4	4
EHG7520-8PoE-4SFP-410GSFP	20-Port GbE L2-Managed Switch including 8x PoE RJ-45, 4x dual-speed SFP Slots of 100/1000 Mbps, and 4x dual-speed SFP Slots of 1/10 Gbps	8x PoE 4x non-PoE	4	4
EHG7520-8SFP-410GSFP	20-Port GbE L2-Managed Switch including 8x dual-speed SFP Slots of 100/1000 Mbps and 4x dual-speed SFP Slots of 1/10 Gbps	8x non-PoE	8	4
EHG7520-12SFP-410GSFP	16-Port GbE L2-Managed Switch including 12x dual-speed SFP Slots of 100/1000 Mbps and 4x dual-speed SFP Slots of 1/10 Gbps	4x non-PoE	12	4
EHG7520-4PoE-12SFP-410GSFP	20-Port GbE L2-Managed Switch including 4x PoE RJ-45, 12x dual-speed SFP Slots of 100/1000 Mbps, and 4x dual-speed SFP Slots of 1/10 Gbps	4x PoE	12	4
EHG7520-16SFP-410GSFP	20-Port GbE L2-Managed Switch including 16x dual-speed SFP Slots of 100/1000 Mbps and 4x dual-speed SFP Slots of 1/10 Gbps	-	16	4



Slim type full managed L2 switch with PoE++

EHG77xx is a slim type fully managed L2 switch with PoE++ ability. The slim design is suitable in limited spaces such as in cabinets. PoE++ allows driving of devices that need 90W power input, such as PTZ cameras. Besides powerful L2 managed functions, EHG77xx also supports 2.5Gbps uplink ports to meet high performance applications.

High-EMC / L2 Managed / Gb / PoE / DIN-Rail Mount / Metal Housing

Coming soon!



Model	Description	10/100/1000 Mbps RJ-45 Port	100/1000 Mbps SFP Slot	100/1000/2500 Mbps SFP Slot	PoE Budget(W)
EHG7704	4-Port GbE L2-Managed Switch	4x non-PoE	-	-	-
EHG7706-225SFP	6-Port GbE L2-Managed Switch including 2x SFP Slots of 100/1000/2500 Mbps	4x non-PoE	-	2	-
EHG7704-4PoE	4-Port GbE L2-Managed Switch including 4x PoE RJ-45	4x PoE++	-	-	240 W
EHG7706-4PoE-225SFP	6-Port GbE L2-Managed Switch including 4x PoE RJ-45 and 2x SFP Slots of 100/1000/2500 Mbps	4x PoE++	-	2	240 W
EHG7708	8-Port GbE L2-Managed Switch	8x non-PoE	-	-	-
EHG7708-2SFP-225SFP	8-Port GbE L2-Managed Switch including 2x dual-speed SFP Slots of 100/1000 Mbps, and 2x SFP Slots of 100/1000/2500 Mbps	4x non-PoE	2	2	-
EHG7708-8PoE	8-Port GbE L2-Managed Switch including 8x PoE RJ-45	8x PoE++	-	-	240 W
EHG7708-4PoE-2SFP-225SFP	8-Port GbE L2-Managed Switch including 4x PoE RJ-45, 2x dual-speed SFP Slots of 100/1000 Mbps, and 2x SFP Slots of 100/1000/2500 Mbps	4x PoE++	2	2	240 W
EHG7711-1SFP-225SFP	11-Port GbE L2-Managed Switch including 4x PoE RJ-45, 4x dual-speed SFP Slots of 100/1000 Mbps, and 4x SFP Slots of 100/1000/2500 Mbps	8x non-PoE	1	2	-
EHG7711-4PoE-1SFP-225SFP	11-Port GbE L2-Managed Switch	4x PoE++ 4x non-PoE	1	2	240 W
EHG7711-8PoE-1SFP-225SFP	11-Port GbE L2-Managed Switch	8x PoE++	1	2	240 W

Concept



Layer-3 Managed Switch

ATOP's advanced Layer-3 (L3) Managed Ethernet switches for harsh environments provide a rugged construction and solid hardened specification for managing advanced networks that demand enhanced routing functionality between different VLANs and IP-Based routing, and meet the technical requirements defined in the relevant guidelines of the IEC 62443 standard.

Our high performance L3 switches carry out real-time packet routing based on a local network's IP address (which can get information from connected routes, dynamic routing and manual configured routes) instead of the MAC address of the destination device. This series of switches supports:

- IPv4 Unicast Static Routing
- Dynamic Routing RIP (Routing Information Protocol) V1/V2
- OSPFv2 (Open Shortest Path First)
- BGP (Border Gateway Protocol)
- VRRP (Virtual Router Redundancy Protocol)
- DVMRP (Distance Vector Multicast Routing Protocol)
- PIM-DM (Protocol Independent Multicast – Dense Mode)
- PIM-SM (Protocol Independent Multicast – Sparse Mode)
- PIM-SSM (Protocol Independent Multicast – Source-Specific Multicast)
- DHCP Server

All models in this series are designed to meet the strictest Level 3 and Level 4 EMC compliance requirements. Our high-performance components guarantee real-time packet switching, even on full load. And they are available in Full-Gigabit versions with 4- to 20-port configurations, RJ-45 or SFP connectors, and PoE support.

Layer-3 Managed DIN-Rail Switch



High-EMC / L3 Managed / Gb / PoE / DIN-Rail Mount / Metal Housing



Model	Description	10/100/1000 Mbps RJ-45 Port	Gigabit SFP Slot	
	EHG7604	4-Port GbE L3-Managed Switch	4x non-PoE	-
	EHG7604-4PoE	4-Port GbE L3-Managed PoE Switch	4x PoE	-
	EHG7604-2SFP	4-Port GbE L3-Managed Switch including 2x Gb SFP Slots	2x non-PoE	2
	EHG7604-2PoE-2SFP	4-Port GbE L3-Managed PoE Switch including 2x PoE RJ-45 and 2x Gb SFP Slots	2x PoE	2
	EHG7604-4SFP	4-Port GbE L3-Managed Switch including 4x Gb SFP Slots	-	4
	EHG7608	8-Port GbE L3-Managed Switch	8x non-PoE	-
	EHG7608-4SFP	8-Port GbE L3-Managed Switch including 4x Gb SFP Slots	4x non-PoE	4
	EHG7608-4PoE-4SFP	8-Port GbE L3-Managed PoE Switch including 4x PoE RJ-45 and 4x Gb SFP Slots	4x PoE	4
	EHG7608-8PoE	8-Port GbE L3-Managed PoE Switch	8x PoE	-

High-EMC / L3 Managed / Gb / PoE / DIN-Rail Mount / Metal Housing



Model		Description	10/100/1000 Mbps RJ-45 Port	100/1000 Mbps SFP Slot	1/10 Gb SFP Slot
	EHG7612-410GSFP	12-Port GbE L3-Managed Switch including 4x 10 Gb Uplink SFP Slots	8x non-PoE	-	4
	EHG7612-4PoE-410GSFP	12-Port Gb L3-Managed PoE Switch including 4x PoE RJ-45 and 4x dual-speed SFP Slots of 1/10 Gbps	4x PoE 4x non-PoE	-	4
	EHG7612-8PoE-410GSFP	12-Port Gb L3-Managed PoE Switch including 8x PoE RJ-45 and 4x dual-speed SFP Slots of 1/10 Gbps	8x PoE	-	4
	EHG7612-4SFP-410GSFP	12-Port GbE L3-Managed Switch including 4x dual-speed SFP Slots of 100/1000 Mbps and 4x dual-speed SFP Slots of 1/10 Gbps	4x non-PoE	4	4
	EHG7612-4SFP-4PoE-410GSFP	12-Port Gb L3-Managed PoE Switch including 4x PoE RJ-45, 4x dual-speed SFP Slots of 100/1000 Mbps, and 4x dual-speed SFP Slots of 1/10 Gbps	4x PoE	4	4
	EHG7616-410GSFP	16-Port GbE L3-Managed Switch including 4x 10 Gb Uplink SFP Slots	12x non-PoE	-	4
	EHG7616-4PoE-410GSFP	16-Port Gb L3-Managed PoE Switch including 4x PoE RJ-45 and 4x dual-speed SFP Slots of 1/10 Gbps	4x PoE 8x non-PoE	-	4
	EHG7616-8PoE-410GSFP	16-Port Gb L3-Managed PoE Switch including 8x PoE RJ-45 and 4x dual-speed SFP Slots of 1/10 Gbps	8x PoE 4x non-PoE	-	4
	EHG7616-4SFP-410GSFP	16-Port GbE L3-Managed Switch including 4x dual-speed SFP Slots of 100/1000 Mbps and 4x dual-speed SFP Slots of 1/10 Gbps	8x non-PoE	4	4
	EHG7616-4SFP-4PoE-410GSFP	16-Port Gb L3-Managed PoE Switch including 4x PoE RJ-45, 4x dual-speed SFP Slots of 100/1000 Mbps, and 4x dual-speed SFP Slots of 1/10 Gbps	4x PoE 4x non-PoE	4	4
	EHG7616-4SFP-8PoE-410GSFP	16-Port Gb L3-Managed PoE Switch including 8x PoE RJ-45, 4x dual-speed SFP Slots of 100/1000 Mbps, and 4x dual-speed SFP Slots of 1/10 Gbps	8x PoE	4	4
	EHG7616-8SFP-410GSFP	16-Port GbE L3-Managed Switch including 8x dual-speed SFP Slots of 100/1000 Mbps and 4x dual-speed SFP Slots of 1/10 Gbps	4x non-PoE	8	4
	EHG7616-8SFP-4PoE-410GSFP	16-Port Gb L3-Managed PoE Switch including 4x PoE RJ-45, 8x dual-speed SFP Slots of 100/1000 Mbps, and 4x dual-speed SFP Slots of 1/10 Gbps	4x PoE	8	4
	EHG7616-12SFP-410GSFP	16-Port GbE L3-Managed Switch including 12x dual-speed SFP Slots of 100/1000 Mbps and 4x dual-speed SFP Slots of 1/10 Gbps	-	12	4

High-EMC / L3 Managed / Gb / PoE / DIN-Rail Mount / Metal Housing (continue)



Model		Description	10/100/1000 Mbps RJ-45 Port	100/1000 Mbps SFP Slot	1/10 Gb SFP Slot
	EHG7620-410GSFP	20-Port GbE L3-Managed Switch including 4x 10 Gb Uplink SFP Slots	16x non-PoE	-	4
	EHG7620-4PoE-410GSFP	20-Port Gb L3-Managed PoE Switch including 4x PoE RJ-45 and 4x dual-speed SFP Slots of 1/10 Gbps	4x PoE 12x non-PoE	-	4
	EHG7620-8PoE-410GSFP	20-Port Gb L3-Managed PoE Switch including 8x PoE RJ-45 and 4x dual-speed SFP Slots of 1/10 Gbps	8x PoE 8x non-PoE	-	4
	EHG7620-4SFP-410GSFP	20-Port GbE L3-Managed Switch including 4x dual-speed SFP Slots of 100/1000 Mbps and 4x dual-speed SFP Slots of 1/10 Gbps	12x non-PoE	4	4
	EHG7620-4SFP-4PoE-410GSFP	20-Port Gb L3-Managed PoE Switch including 4x PoE RJ-45, 4x dual-speed SFP Slots of 100/1000 Mbps, and 4x dual-speed SFP Slots of 1/10 Gbps	4x PoE 8x non-PoE	4	4
	EHG7620-4SFP-8PoE-410GSFP	20-Port Gb L3-Managed PoE Switch including 8x PoE RJ-45, 4x dual-speed SFP Slots of 100/1000 Mbps, and 4x dual-speed SFP Slots of 1/10 Gbps	8x PoE 4x non-PoE	4	4
	EHG7620-8SFP-410GSFP	20-Port GbE L3-Managed Switch including 8x dual-speed SFP Slots of 100/1000 Mbps and 4x dual-speed SFP Slots of 1/10 Gbps	8x non-PoE	8	4
	EHG7620-12SFP-410GSFP	20-Port GbE L3-Managed Switch including 12x dual-speed SFP Slots of 100/1000 Mbps and 4x dual-speed SFP Slots of 1/10 Gbps	4x non-PoE	12	4
	EHG7620-12SFP-4PoE-410GSFP	20-Port Gb L3-Managed PoE Switch including 4x PoE RJ-45, 12x dual-speed SFP Slots of 100/1000 Mbps, and 4x dual-speed SFP Slots of 1/10 Gbps	4x PoE	12	4
	EHG7620-16SFP-410GSFP	20-Port GbE L3-Managed Switch including 16x dual-speed SFP Slots of 100/1000 Mbps and 4x dual-speed SFP Slots of 1/10 Gbps	-	16	4

Managed Rack-Mount Switch

Flexibility

You can choose from among 16 different Switching or Layer-3 Routing Core versions (based on power supply and uplink port configurations) and five different 4- to 8-Port modules to customize your device in a very simple way.

Designed for PoE

RHG7X28 supports up to 24 Gigabit ports in any 4- or 8-port configuration. Specifically designed to bring power through Ethernet cables to virtually anywhere, a maximum output Power over Ethernet of 720W over the 24 ports can be achieved (Configuration for 802.3af PoE / 802.3at PoE+).



Available in **3 power input variants**, RHG7X28 is UL/EN62368 certified by specifying the complete safety requirements for control equipment and designed to handle the harshest of environments. Its fanless design and EMC Level 3 protection guarantees operations in wide temperatures from -40°C to +75°C, and with 24 PoE ports running full power, it is a device that can be trusted to work in your field or environment with minimum effort.

Power and versatility

Layer-3 versions support IPv4 and IPv6 Static Routing to power communication to indirectly connected remote networks. Layer 3 routing rich features further include RIPv1/v2, OSPFv2, BGP, PIM Dense Mode and Sparse Mode, DVMRP and VRRP for Routing Redundancy. Through ERPS, RHG7X28 supports a network self-recovery time of under 20ms – even on full load. Most redundant ring topologies are supported: they are ITU-T G.8032 ERPS Ring, IEEE802.1D-2004 RSTP, STP, MSTP, MRP (Client and Manager), iA-Ring, iA-Chain and many other compatible rings.

Secure

Protect your LAN from eavesdropping, tampering and impersonation through 802.1AE MACsec hop-by-hop encryption. With no additional latency and 100% Gigabit throughput guaranteed, dedicated modules provide you with the ultimate security solution (Layer-3 version only) – enabling shorter time to task completion ratio.

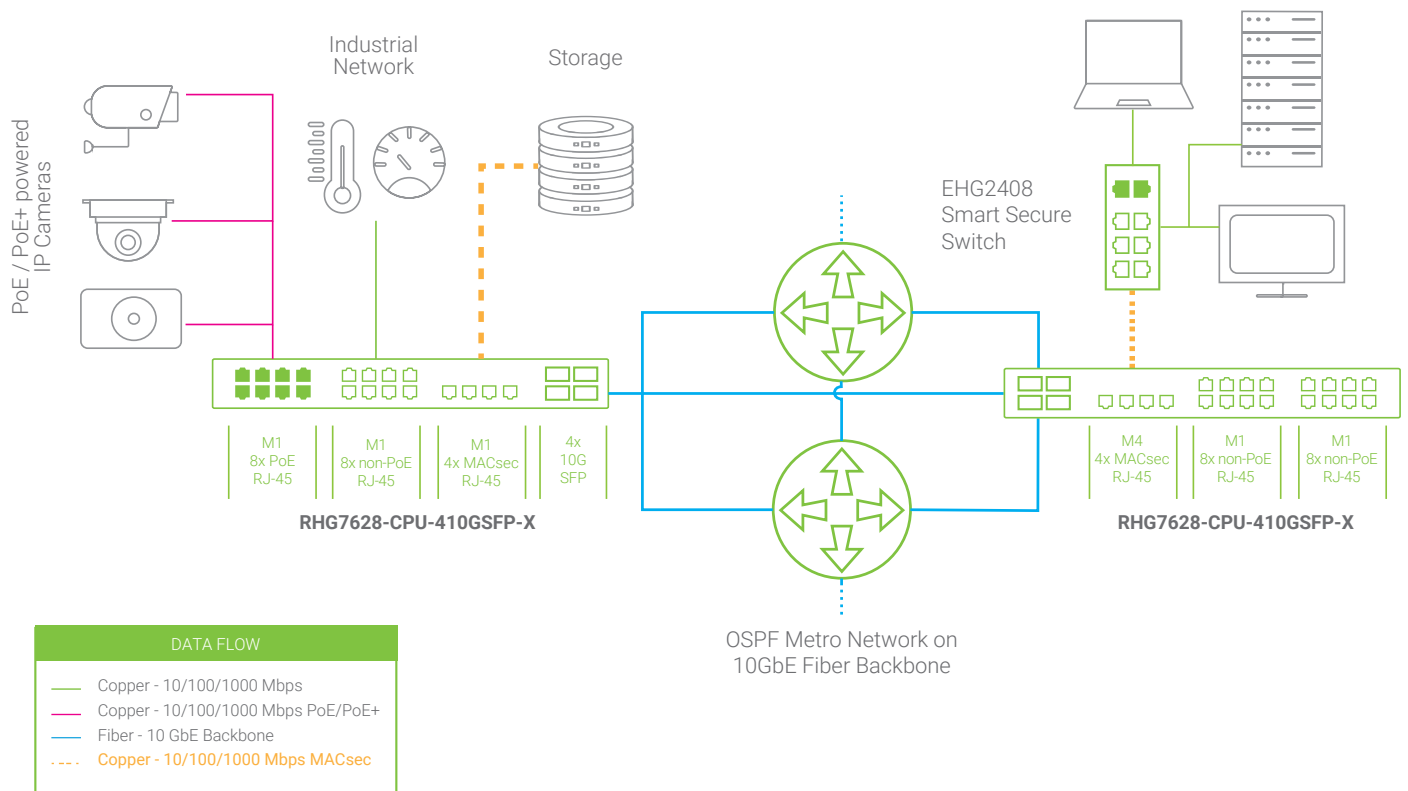

Modular Concept

ATOP RHG Series can be customized based on customers' demand to meet each kind of scenarios with the swappable modules. Among eight different models and five different modules for each, capability of the switch can be expanded and changed as time goes by. Meanwhile, software helps to set up the swapped modules automatically, extra setting efforts are not required.



RHG7628-CPU-410GSFP-R
Main unit, with 4x 10 Gigabit SFP uplink ports and redundant AC power input



RHG7X28-M1
Module with 8x Gb PoE RJ-45



RHG7X28-M2
Module with 8x Gb non-PoE RJ-45



RHG7X28-M5
Module with 4x Gb MACsec-capable SFP Slots

24-Port Gb L3-Managed Switch including
4x 1/10 Gbps SFP Slots,
4x Gb SFP/RJ-45 with MACsec,
8x for PoE RJ-45, and 8x for non-PoE RJ-45



Switch Core Platforms

ATOP RHG Series rackmount switch provides full scalability and flexibility. With different hardware versions, RHG Series can meet the needs of 10G uplinks, Layer-2 manageable, or even Layer-3 manageable.

For specific Layer-2 and Layer-3 switch features, please refer to the corresponding datasheets.

High-EMC / L2 & L3 Managed / Gb / PoE / Rack Mount / Metal Housing



Manageable	Uplink port	Redundant Power Supply for CPU Board (100-240 VAC)	Single Power Supply for CPU Board (100-240 VAC)	Redundant AC/DC Power Input for Power Board	Redundant DC 48-56 VDC Power Supply
Layer 2 Managed*	4x GbE	RHG7528-CPU-4SFP-R	RHG7528-CPU-4SFP	RHG7528-CPU-4SFP-MR	RHG7528-CPU-4SFP-DC
	4x 10 GbE	RHG7528-CPU-410GSFP-R	RHG7528-CPU-410GSFP	RHG7528-CPU-410GSFP-MR	RHG7528-CPU-410GSFP-DC
Layer 3 Managed	4x GbE	RHG7628-CPU-4SFP-R	RHG7628-CPU-4SFP	RHG7628-CPU-4SFP-MR	RHG7628-CPU-4SFP-DC
	4x 10 GbE	RHG7628-CPU-410GSFP-R	RHG7628-CPU-410GSFP	RHG7628-CPU-410GSFP-MR	RHG7628-CPU-410GSFP-DC

* Layer 2 models do not support MACsec M4-M5 modules

Modules

Five different swappable modules are available for the RHG7X28 Series, available in up to 74 combinations. With modules of 8x PoE, 8x non-PoE, and 8x SFP, customization made easy to meet any demand.

a. RHG7X28-M1

8-Port PoE Gb RJ-45 Module

- i. 8x 10/100/1000BASE-T PoE RJ-45
- ii. IEEE 802.3at PoE+ 30 W/port & IEEE 802.3af PoE 15 W/port
- iii. Power budget 240 W/module



b. RHG7X28-M2

8-Port non-PoE Gb RJ-45 Module

- i. 8x 10/100/1000BASE-T non-PoE RJ-45



c. RHG7X28-M3

8-Port Gb SFP Module

- i. 8x 100/1000BASE-FX SFP Slots
- ii. Software-controlled port speed of 100 Mbps or 1000 Mbps

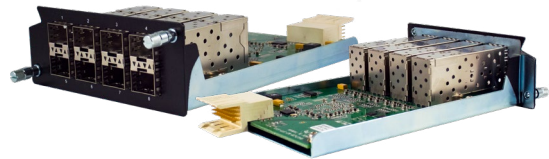

d. RHG7X28-M4

4-Port MACsec Gb SFP Module*

- i. 4x 10/100/1000BASE-T MACsec RJ-45
- ii. All ports are encrypted with hardware-based MACsec



e. RHG7X28-M5

4-Port MACsec Gb SFP Module*

- i. 4x 100/1000BASE-FX SFP Slots
- ii. All ports are encrypted with hardware-based MACsec



* Layer 2 CPU-core models (RHG7528-CPU-XX) do not support MACsec M4 & M5 modules.

Industry-specific Networking

ATOP's wide range of resilient and easy-to-deploy industrial Ethernet switches are engineered and manufactured in Taiwan. Equipped with industrial-grade reliability, network redundancy, scalability, seamless integrated security and industrial certifications; our solutions are optimized for performance, efficiency and best price-to-performance ratio. With our abundance of product options in conjunction with extensive knowledge of various protocol standards used in industries such as railway, transport, energy, and utilities, we can be sure to find a solution for your application – regardless of its environment and scale.

Industry Ethernet for Substation Automation and Smart Grids

Over the decades, various communication protocols have been developed to manage power grid networks and components such as RTUs and IEDs – and even control centers. This results in adoption of different standards by numerous countries around the world. While different protocols have varying strengths and dynamics, Distributed Network Protocol (DNP 3) has become the standard adopted in North America. Europe has relied mainly on IEC 60870-5 101/103/104, with much of the world using Modbus protocol in tightly controlled communication dynamics, due to its openness and ease.

To simplify all these and achieve interoperability, IEC 61850 was developed to provide a standard communication protocol for substations and power grid automation. Specializing its domain knowledge in power grid substations, IEC 61850 is an object-oriented, Ethernet based protocol that uses a data modeling to clearly describe each component of a power grid or substation as standard logical nodes – such as object processes, protection, control, and functionality to perform monitoring, metering, real-time protection and control.

This specialization enables data access to the power grid system to yield more details. And to further improve reliability and performance, **IEC 61850 Part 3 also specifies the hardware and network suitability requirements** – such as electro-magnetic immunity (EMI), intelligent electronic devices, surge protection, vibration and shock resistance, and the temperature range in which devices must be able to function. **ATOP's IEC61850-3 switches comply with these specifications.**



IEC 61850-3 Device Compliancy Specifications

- Operate in a temperature range of -40°C to 85°C.
- Be capable of reliably handling long distance transmissions through Fiber optic connectivity.
- Guarantee QoS (Quality of Service) management and real-time packet switching for GOOSE event messages.
- Guarantee a level of redundancy that minimizes packet loss. Ring topologies should be supported, and zero-packet-loss technologies such as HSR (High availability Seamlessly Redundancy) or PRP (Parallel Redundancy Protocol) are strongly recommended to be supported.
ATOP's devices support RSTP (Rapid Spanning-Tree Protocol) and ERPS rings. When equipped with HSR/PRP modules, our innovative RHG9528 switch guarantees against loss of GOOSE packets.
- Comes with a wide tolerance for vibrations and shocks. **ATOP's MIL-STD-810F device fully complies.**
- Comes with a tough electromagnetic immunity and complies with emission standards according to IEC 61850-3.
- Comes with at least Level 3 EMC protection; have at least Level 4 ESD, EFT and Surge protection; and have at least Level 5 PFMF and Damped Oscillatory Magnetic Field immunity.

Our Regulatory Approvals

Test	Version	Item		Value	Level	Criterion
IEC 61000-4-2	2008	ESD	Contact Discharge Air Discharge	±8kV ±15kV	4 4	B B
IEC 61000-4-3	2010	RS	Enclosure Port	10(V/m), 80-1000MHz, 80% AM, 1-3GHz	3	A
IEC 61000-4-4	2012	EFT	AC Power Port DC Power Port Signal Port	±4.0KV@ 2.5KHz ±4.0KV@ 2.5KHz ±2.0KV@ 5.0KHz	4 4 4	B B B
IEC 61000-4-5	2014	Surge	AC Power Port AC Power Port DC Power Port DC Power Port Signal Port	Line-to-Line ± 2.0 kV Line-to-Earth ± 4.0 kV Line-to-Line ±1.0 kV Line-to-Earth ± 2.0 kV Line-to-Earth ± 4.0 kV	4 4 3 3 4	B B B B B
IEC 61000-4-6	2013	CS	AC Power Port DC Power Port Signal Port	10 V, 150 kHz-80 MHz, 80% AM 10 V, 150 kHz-80 MHz, 80% AM 10 V, 150 kHz-80 MHz, 80% AM	3 3 3	A A A
IEC 61000-4-8	2009	PFMF	(Enclosure)	100 A/m continuous,1000 A/m for 3 S	5	A
IEC61000-4-10	2000	Damped Oscillatory magnetic Field	(Enclosure)	100 A/m, 100 kHz, 1 MHz	5	A
IEC 61000-4-11	2004	DIP	AC Power Port	Drop 70% for 3 times/S (1 Period) Drop 40% for 3 times/1 mS (50 Period) Drop 100% for 3 times/50 mS (5 & 50 Period)	N/A N/A N/A	A A A
IEC 61000-4-12	2006	Damped Oscillatory	AC Power Port Signal Port	2.5KV common,1KV differential mode @ 1 MHz 2.5KV common,1KV differential mode @ 1 MHz	3 3	B B

IEC 61850-3 Managed DIN-Rail Switch

IEC 61850-3 / L2 & L3 Managed / Gb & FE / DIN-Rail Mount / Metal Housing



Model	Description	10/100 Mbps RJ-45 Port	10/100/1000 Mbps RJ-45 Port	Gigabit SFP Slot	Power Input
	EHG9508-2SFP	-	6	2	Dual 24-57 VDC
	EHG9508-2SFP-HV	-	6	2	110-370 VDC
	EHG9508-2SFP-AC	-	6	2	100-240 VAC
	EHG9608-2SFP	-	6	2	Dual 24-57 VDC
	EHG9608-2SFP-HV	-	6	2	110-370 VDC
	EHG9608-2SFP-AC	-	6	2	100-240 VAC
	EH9711-3SFP-DC	8	-	3 (100/1000 Mbps)	24-48 VDC
	EH9711-3SFP-HV	8	-	3 (100/1000 Mbps)	1x 24-48 VDC & 1x 110-300 VDC / 110-240 VAC
	EHG9512-4SFP	-	8	4	Dual 24-57 VDC
	EHG9512-4SFP-HV	-	8	4	110-370 VDC
	EHG9512-4SFP-AC	-	8	4	100-240 VAC
	EHG9612-4SFP	-	8	4	Dual 24-57 VDC
	EHG9612-4SFP-HV	-	8	4	110-370 VDC
	EHG9612-4SFP-AC	-	8	4	100-240 VAC

IEC 61850-3 Rack-Mount Gigabit Managed Switch

RHG9X28 is a modular rackmount switch with IEC61850-3 certification ideal for substation automation. Customization made easy with the swappable modules.

Conceived for telecom and power applications, the modular architecture of RHG9X28 allows it to be deployed simply as either a managed switch, Access/Aggregation switch, a PTP Transparent clock, a PTP Boundary clock, a SyncE clock, or as an IEC62439-3 (HSR) and IEC62439-4 (PRP) device. Its rugged design, wide temperature range and high EMC protection, combined with IEC61850-3 and IEEE1613 certifications for the Power Sector, makes the RHG9X28 Series an ideal solution for IEC61850 substation use.

The RHG9728 and RHG9828 further incorporate PoE++ features to supply up to 90 W power per port, allowing cleaner topologies and less wiring in large network systems. Hot-swappable power modules can be replaced without stopping operation, which is ideal for utilities and critical processes.



High Availability for zero packet loss (HSR/PRP)

When equipped with High-Availability HSR/PRP modules, the RHG9X28 series complies with the most stringent redundancy requirements. It ensures zero packet loss, no misoperation or damage and that GOOSE packets/messages arrive at their intended destination. It also provides a network redundant self-recovery time of under 20ms, even on full load, which enables a reliable network to be built with almost any redundant ring topology using traditional redundancy protocols. RHG9X28 supports: ITU-T G.8032 ERPS Ring; IEEE802.1D-2004 RSTP; STP; MSTP; MRP (Master/ Client); iA-Ring; iA-Chain; and many other compatible rings protocols for network redundancy. And with a Multifunctional web dashboard, it offers intelligent features such as Quality of service (QoS), IGMP, and Port mirroring, and meet the technical requirements defined in the relevant guidelines of the IEC 62443 standard.

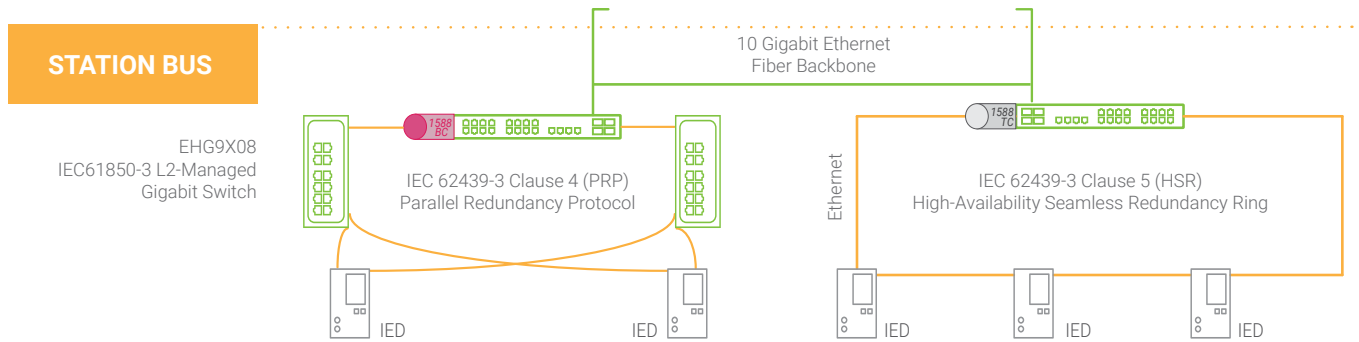

IEEE1588v2 PTP Transparent and Boundary Clock

Power applications require some of the most time-sensitive networks, and this is where PTP clocks help.

Boundary Clock (BC) is usually built in a managed switch. To GMC (Grandmaster Clock), the BC acts as a Slave; and to Slaves in downstream, the BC acts as a Master.

With this intermediate layer, the GMC only has to take care of the topmost BC's synchronization. Meanwhile, the BC will synchronize with other downstream BCs or Slaves.

To form a good Boundary Clock (BC), accurate timestamps generated by the hardware itself are required in case of Grandmaster Clock (GMC) failure or uplink failure. In addition, a built-in oscillator is a must to help lower the time drift.

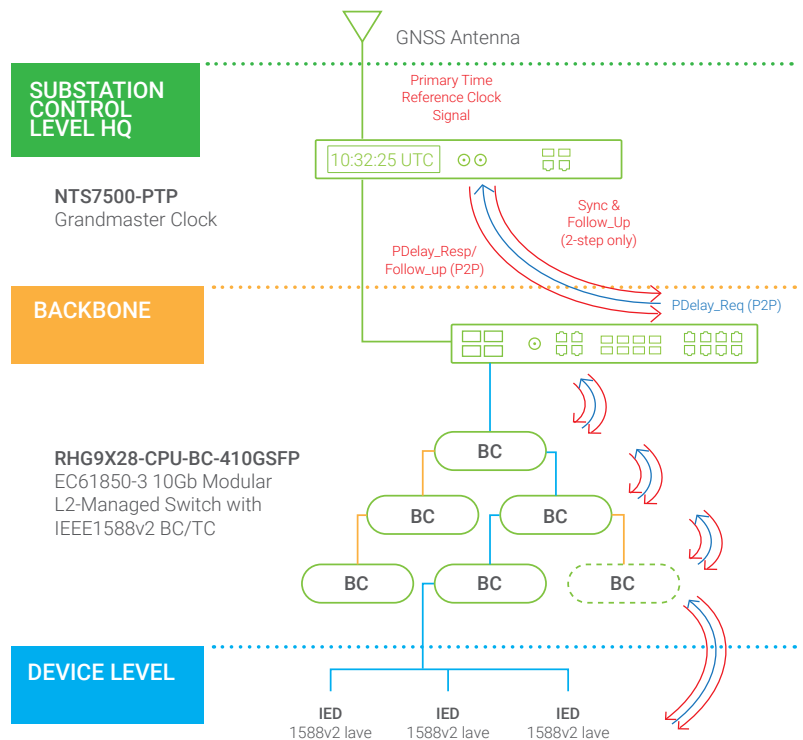



IEC 61850-3 / PTP / HSR / PRP / L2 & L3 Managed / Gb / Rack Mount / Metal Housing

NEW

Coming soon!



Model	Description	1/10 Gb SFP Slot	Module Slot	Hardware-Based Boundary Clock	Power Input	
	RHG9528-410GSFP-DC	IEC61850-3 10Gb Modular L2-Managed Switch with Redundant DC Power Input	4	3	-	Redundant 24-120 VDC
	RHG9528-410GSFP-AC	IEC61850-3 10Gb Modular L2-Managed Switch with Redundant AC Power Input	4	3	-	Redundant 100-240 VAC
	RHG9528-410GSFP-HV	IEC61850-3 10Gb Modular L2-Managed Switch with Redundant High-Voltage DC Power Input	4	3	-	Redundant 120-380 VDC
	RHG9528-410GSFP-SB-DC	IEC61850-3 10Gb Modular L2-Managed Switch with Redundant High-Voltage DC Power Input	4	3	Y	Redundant 24-120 VDC
	RHG9528-410GSFP-SB-AC	IEC61850-3 10Gb Modular L2-Managed Switch with Hardware-based BC, SyncE, and Redundant AC Power Input	4	3	Y	Redundant 100-240 VAC
	RHG9528-410GSFP-SB-HV	IEC61850-3 10Gb Modular L2-Managed Switch with Hardware-based BC, SyncE supported, and Redundant High-Voltage DC Power Input	4	3	Y	Redundant 120-380 VDC
	RHG9628-410GSFP-DC	IEC61850-3 10Gb Modular L3-Managed Switch with Redundant DC Power Input	4	3	-	Redundant 24-120 VDC
	RHG9628-410GSFP-AC	IEC61850-3 10Gb Modular L3-Managed Switch with Redundant AC Power Input	4	3	-	Redundant 110-240 VAC
	RHG9628-410GSFP-HV	IEC61850-3 10Gb Modular L3-Managed Switch with Redundant High-Voltage DC Power Input	4	3	-	Redundant 120-380 VDC
	RHG9628-410GSFP-SB-DC	IEC61850-3 10Gb Modular L3-Managed Switch with Hardware-based BC, SyncE supported, and Redundant DC Power Input	4	3	Y	Redundant 24-120 VDC
	RHG9628-410GSFP-SB-AC	IEC61850-3 10Gb Modular L3-Managed Switch with Hardware-based BC, SyncE, and Redundant AC Power Input	4	3	Y	Redundant 110-240 VAC
	RHG9628-410GSFP-SB-HV	IEC61850-3 10Gb Modular L3-Managed Switch with Hardware-based BC, SyncE supported, and Redundant High-Voltage DC Power Input	4	3	Y	Redundant 120-380 VDC
 <p>Concept</p>	RHG9728-4SFP	IEC61850-3 10Gb Modular L2-Managed Switch with Hot-Swappable Power Modules	4	3	Y	3x Modular Hot Swappable Power Modules (2x 24-120 VDC/120-380VDC/100-240 VAC, 1x 48-57 VDC PoE)
	RHG9828-4SFP	IEC61850-3 10Gb Modular L3-Managed Switch with Hot-Swappable Power Modules	4	3	Y	

Modules

Model	Description	10/100/1000 Mbps RJ-45 Port	100/1000 Mbps SFP Slot	IEEE 1588v2	SyncE	IRIG-B	HSR/PRP	
For RHG9528/9628 series								
	RHG9528-M1	8-Port Gb RJ-45 Module	8	-	TC & BC	Y	N	
	RHG9528-M2	8-Port Gb SFP Module	-	8	TC & BC	Y	N	
	RHG9528-M3	4-Port Gb RJ-45 Module with 1x RS-485 Terminal Block for IRIG-B Output	4	-	TC & BC	Y	Y (1x terminal block)	
	RHG9528-M4	4-Port Gb SFP Module with 1x RS-485 Terminal Block for IRIG-B Output	-	4	TC & BC	Y	Y (1x terminal block)	
	RHG9528-M5	4-Port Gb RJ-45 Module with HSR/PRP supported	4	-	TC & BC	N	N	Y (2x Groups)
	RHG9528-M6	4-Port Gb SFP Module with HSR/PRP supported	-	4	TC & BC	N	N	Y (2x Groups)
For RHG9728/9828 series								
RHG9728-8PoE	8-Port Gb RJ-45 Module with PoE	8x PoE	-	-	-	-	-	
RHG9728-8G	8-Port Gb RJ-45 Module	8x non-PoE	-	-	-	-	-	
RHG9728-8SFP	8-Port Gb SFP Module	-	8	-	-	-	-	

PTP Grandmaster Precision Timing

With premium holdover performance through an advanced OCXO oscillator, ATOP grandmaster clocks provide ns-accurate timing to power networks via IEEE1588v2 (Precision Time Protocol) referencing GNSS sources. Rugged and compact half-rackmount hardware, as well as support for IEC62439-3 Clause 5 PRP (Parallel Redundancy Protocol) ensure practicability and reliability in harsh environments. NTS7500 is designed specifically for power applications, supporting PTP power profiles (IEEE C37.238 & IEC/IEEE 61850-9-3). NTS8600 offers even higher applicability and flexibility through multiple PTP Profiles (IEEE C37.238, IEC/IEEE 61850-9-3, G.8265.1, G.8275.1, G.8275.2, 802.1AS).

PTP Grandmaster Precision Timing / IEC 61850-3 / Rack Mount / Metal Housing



Model	Description	PTP Profile	NTP	Gigabit Synchronization Port	10/100 Mbps Management Port	PPS	10MHz	IRIG-B	
	NTS7500-NTP	Industrial Grandmaster Clock	-	√	2 x Combo	-	1 x BNC	1 x BNC	Optional
	NTS7500-PTP	Industrial Grandmaster Clock	Default Profile IEC 61850-9-3 IEEE C37.238	√	2 x Combo	-	1 x BNC	1 x BNC	Optional
	NTS8600	Power-Grade Industrial Grandmaster Clock	Default Profile IEC 61850-9-3 IEEE C37.238 IEEE 802.1AS ITU-T G.8275.1 ITU-T G.8275.2 ITU-T G.8265.1	√	2 x RJ-45	1 x RJ-45	1 x BNC	1 x BNC	4 x RS485
	NTS8600-SFP	Power-Grade Industrial Grandmaster Clock	Default Profile IEC 61850-9-3 IEEE C37.238 IEEE 802.1AS ITU-T G.8275.1 ITU-T G.8275.2 ITU-T G.8265.1	√	2 x SFP	1 x RJ-45	1 x BNC	1 x BNC	4 x RS485

Railway Networking: EN50155 and EN50121-4

EN50155 is a widely recognized international standard for electronic equipment in railway applications. It defines the criteria that network devices must comply with – such as wide temperature ranges; humidity, shock, and vibration resistance; power supplies, electromagnetic interference, power surges, EMC, electrostatic discharges (ESD) and transient factors.

EN50121-4, on the other hand, even though being part of EN50155, applies to the signaling and track-side apparatus installed in railway environments.

ATOP's railway compliant, EN50155 and EN50121-4 certified product series offer powerful industrial ethernet switches with advanced features that are encased in robust and reliable housing up to IP67, making them highly suitable for use in signal control networks.

Selected products are NEMA TS-2 certified, allowing them to be used in the most demanding of traffic control applications



Mechanical Requirements

• Rolling stock

- Vibration: Category < 0,3 g
- Frequency range: 5 – 150 Hz
- Acceleration: 5g
- Shock (half sine): Long/ Trans. /Vert Axis - Peak acceleration: 5g/2g/1g
- Duration: 50 ms / 20 ms / 20 ms

• Ground equipment N/A

Temperature Requirements

Category	Internal cabinet temperature range	Ambient board temperature range	GAIA converter modules temperature range
T1	-25/+55°C	-25/+70°C	Industrial line: -40/+71°C ambient
T2	-40/+55°C	-40/+70°C	
T3	-25/+70°C	-25/+85°C	Hi-rel line: -40/+85°C ambient
T4	-40/+70°C	-40/+85°C	

Humidity 2 x 25 h @ 40°C

Electromagnetic Compatibility

- CE; FCC
- 24 VDC: 500 Veff/ 50 Hz/ 1 min
- 48 VDC: 500 Veff/ 50 Hz/ 1 min
- 72-125 VDC : 1,000 Veff/ 50 Hz/ 1 min
- 125-315 V: 1,500 Veff/ 50 Hz/ 1 min
- For other details refer to EN50155

Deployment Scenario

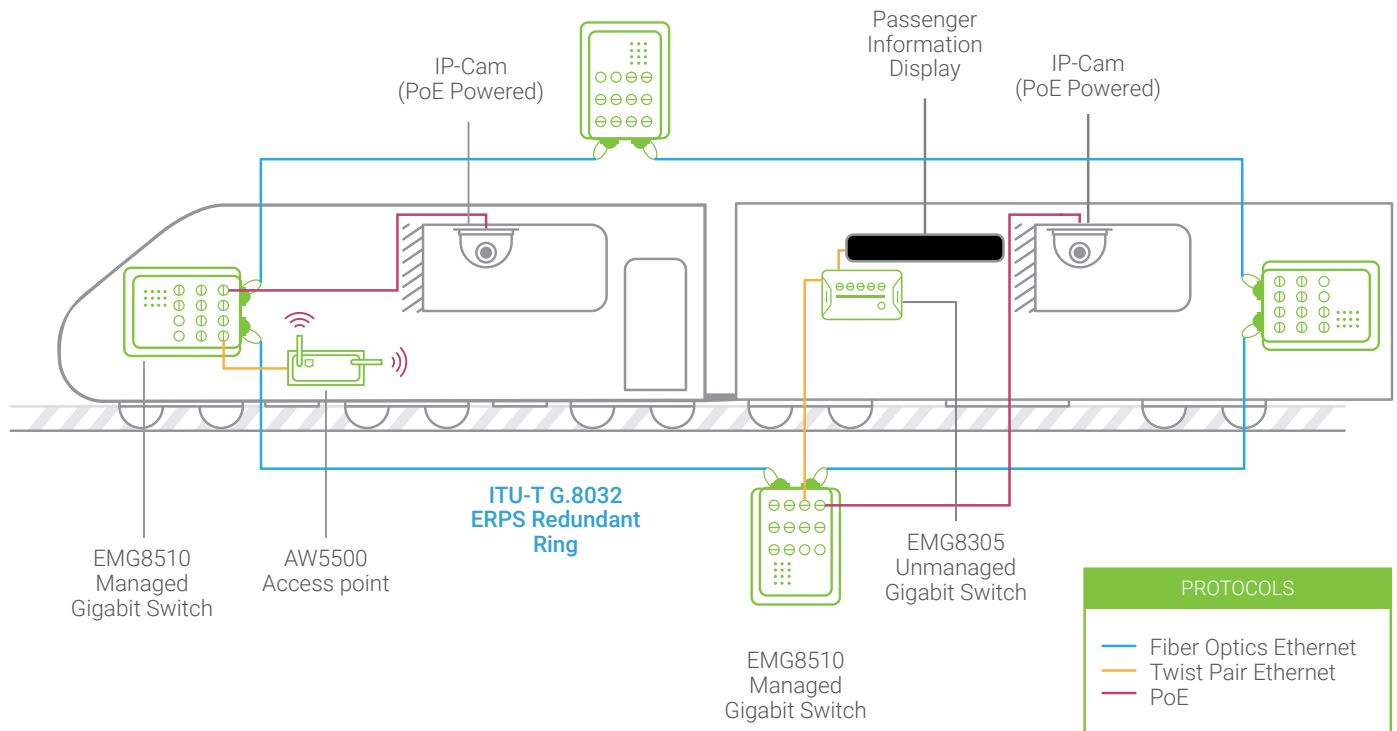

EN50155 Railway Unmanaged Switch

Unmanaged / Gb / PoE / DIN-Rail Mount / Metal Housing



Model	Description	10/100/1000 Mbps RJ-45 Port	Gigabit SFP Slot	Certification
	EHG7305	5-Port GbE Unmanaged Atex Switch	5x non-PoE	-
	EHG7306-1SFP	6-Port GbE Unmanaged Atex Switch including 1x Gb uplink SFP slot	5x non-PoE	1
	EHG7307-2SFP	7-Port GbE Unmanaged Atex Switch including 2x Gb uplink SFP slots	5x non-PoE	2
	EHG7305-4PoE	5-Port Gb PoE Unmanaged Atex Switch including 4x PoE RJ-45	4x PoE 1x non-PoE	-
	EHG7306-4PoE-1SFP	6-Port Gb PoE Unmanaged Atex Switch including 4x PoE RJ-45 & 1x Gb uplink SFP slot	4x PoE 1x non-PoE	1
	EHG7307-4PoE-2SFP	7-Port Gb PoE Unmanaged Atex Switch including 4x PoE RJ-45 & 2x Gb uplink SFP slots	4x PoE 1x non-PoE	2
				L Class 1 Division 2 ATEX Zone 2 EN50155 EN50121-4

Unmanaged / Gb / Wall Mount / Waterproof / Aluminum Housing







Model	Description	10/100/1000 Mbps M12 Port	M12 Type	Notes
	EMG8305-M12-A	IP67 5-Port Gb M12 Unmanaged Switch including 5x A-coded M12 Connectors	5	A-coded
	EMG8305-M12-X	IP67 5-Port Gb M12 Unmanaged Switch including 5x X-coded M12 Connectors	5	X-coded
				Profinet packet prioritization

EN50155 Managed Switch

High-EMC / L2 & L3 Managed / Gb / PoE / DIN-Rail Mount / Metal Housing



Model		Description	10/100 /1000 Mbps RJ-45 Port	Gigabit SFP Slot
	EHG7504	4-Port Gb L2-Managed Switch	4x non-PoE	-
	EHG7504-4PoE	4-Port Gb L2-Managed PoE Switch	4x PoE	-
	EHG7504-2SFP	4-Port Gb L2-Managed Switch including 2x Gb SFP Slots	2x non-PoE	2
	EHG7504-2PoE-2SFP	4-Port Gb L2-Managed PoE Switch including 2x PoE RJ-45 and 2x Gb SFP Slots	2x PoE	2
	EHG7504-4SFP	4-Port Gb L2-Managed Switch including 4x Gb SFP Slots	-	4
	EHG7604	4-Port GbE L3-Managed Switch	4x non-PoE	-
	EHG7604-4PoE	4-Port GbE L3-Managed PoE Switch	4x PoE	-
	EHG7604-2SFP	4-Port GbE L3-Managed Switch including 2x Gb SFP Slots	2x non-PoE	2
	EHG7604-2PoE-2SFP	4-Port GbE L3-Managed PoE Switch including 2x PoE RJ-45 and 2x Gb SFP Slots	2x PoE	2
	EHG7604-4SFP	4-Port GbE L3-Managed Switch including 4x Gb SFP Slots	-	4
	EHG7508	8-Port Gb L2-Managed Switch	8x non-PoE	-
	EHG7508-4SFP	8-Port Gb L2-Managed Switch including 4x Gb SFP Slots	4x non-PoE	4
	EHG7508-4PoE-4SFP	8-Port Gb L2-Managed PoE Switch including 4x PoE RJ-45 and 4x Gb SFP Slots	4x PoE	4
	EHG7508-8PoE	8-Port Gb L2-Managed PoE Switch	8x PoE	-
	EHG7608	8-Port GbE L3-Managed Switch	8x non-PoE	-
	EHG7608-8PoE	8-Port GbE L3-Managed Switch including 4x Gb SFP Slots	4x non-PoE	4
	EHG7608-4SFP	8-Port GbE L3-Managed PoE Switch including 4x PoE RJ-45 and 4x Gb SFP Slots	4x PoE	4
	EHG7608-4PoE-4SFP	8-Port GbE L3-Managed PoE Switch	8x PoE	-

L2 & L3 Managed / Gb / Wall Mount / Waterproof / Aluminum Housing



Model		Description	10/100/1000 Mbps M12 Port	Gigabit SFP Slot	Power Input
	EMG8508	IP67 8-Port Gb M12 L2-Managed Switch	8x non-PoE	-	12-57 VDC
	EMG8508-4PoE	IP67 8-Port Gb M12 L2-Managed PoE Switch including 4x PoE M12 Connectors	4x PoE 4x non-PoE	-	45-57 VDC for 802.3af mode 51-57 VDC for 802.3at mode
	EMG8508-8PoE	IP67 8-Port Gb M12 L2-Managed PoE Switch	8x PoE	-	45-57 VDC for 802.3af mode 51-57 VDC for 802.3at mode
	EMG8508-HV	IP67 8-Port Gb M12 L2-Managed Switch with High-Voltage Power Input of 50-145 VDC	8x non-PoE	-	50-145 VDC
	EMG8608	IP67 8-Port Gb M12 L3-Managed Switch	8x non-PoE	-	12-57 VDC
	EMG8608-4PoE	IP67 8-Port Gb M12 L3-Managed PoE Switch including 4x PoE M12 Connectors	4x PoE 4x non-PoE	-	45-57 VDC for 802.3af mode 51-57 VDC for 802.3at mode
	EMG8608-8PoE	IP67 8-Port Gb M12 L3-Managed PoE Switch	8x PoE	-	45-57 VDC for 802.3af mode 51-57 VDC for 802.3at mode
	EMG8608-HV	IP67 8-Port Gb M12 L3-Managed Switch with High-Voltage Power Input of 50-145 VDC	8x non-PoE	-	50-145 VDC
	EMG8510-2SFP	IP67 10-Port Gb M12 L2-Managed Switch including 2x Gb SFP Slots	8x non-PoE	2	12-57 VDC
	EMG8510-4PoE-2SFP	IP67 10-Port Gb M12 L2-Managed PoE Switch including 4x PoE M12 Connectors and 2x Gb SFP Slots	4x PoE 4x non-PoE	2	45-57 VDC for 802.3af mode 51-57 VDC for 802.3at mode
	EMG8510-8PoE-2SFP	IP67 10-Port Gb M12 L2-Managed PoE Switch including 8x PoE M12 Connectors and 2x Gb SFP Slots	8x PoE	2	45-57 VDC for 802.3af mode 51-57 VDC for 802.3at mode
	EMG8510-2SFP-HV	IP67 10-Port Gb M12 L2-Managed Switch including 2x Gb SFP Slots and with High-Voltage Power Input of 50-145 VDC	8x non-PoE	2	50-145 VDC
	EMG8610-2SFP	IP67 10-Port Gb M12 L3-Managed Switch including 2x Gb SFP Slots	8x non-PoE	2	12-57 VDC
	EMG8610-4PoE-2SFP	IP67 10-Port Gb M12 L3-Managed PoE Switch including 4x PoE M12 Connectors and 2x Gb SFP Slots	4x PoE 4x non-PoE	2	45-57 VDC for 802.3af mode 51-57 VDC for 802.3at mode
	EMG8610-8PoE-2SFP	IP67 10-Port Gb M12 L3-Managed PoE Switch including 8x PoE M12 Connectors and 2x Gb SFP Slots	8x PoE	2	45-57 VDC for 802.3af mode 51-57 VDC for 802.3at mode
	EMG8610-2SFP-HV	IP67 10-Port Gb M12 L3-Managed Switch including 2x Gb SFP Slots and with High-Voltage Power Input of 50-145 VDC	8x non-PoE	2	50-145 VDC

Marine

ATOP's marine solutions are certificated for ships and offshore structures, ensuring safety reliability, and environmental international requirements.

High-EMC / L2 Managed / Gb / 10Gb SFP / PoE / DIN-Rail Mount / Metal Housing



Model	Description	10/100/1000 Mbps RJ-45 Port	1/10 Gb SFP Slot	100/1000 Mbps SFP Slot	Power Input
	EHG7512	12-Port High-Bandwidth Industrial Managed Gigabit PoE Switch	4 to 8	4	0 or 4
	EHG7516	16-Port High-Bandwidth Industrial Managed Gigabit PoE Switch	0 to 12	4	4 to 12
	EHG7520	20-Port High-Bandwidth Industrial Managed Gigabit PoE Switch	0 to 16	4	4 to 16
					9-57 VDC for non-PoE models 45-57 VDC for 802.3af mode 51-57 VDC for 802.3at mode

Oil & Gas

Oil and gas are the most important assets to be protected in any hazardous environments. For networks in these areas—which are usually filled up with flammable gases, liquids, vapors, and combustible dusts—non-sparking components and devices are the always best choices.

In order to achieve the standard of UL Class I Division II and ATEX, ATOP designs the High-EMC Series for gas, oil, and mine plant solutions. In areas that are spark-sensitive, or environments that require instruments with no general arcing parts, the ATOP High-EMC Series are also recommended, because disasters may be caused with only one small spark.

ATOP High-EMC EHG73XX Series is the ideal switch for high-EMC environments, to help keep the property and people away from the risk of switch explosion.

Unmanaged / Gb / PoE / DIN-Rail Mount / Metal Housing



Model	Description	10/100/1000 Mbps RJ-45 Port	100/1000 Mbps 1000 Mbps SFP Slot	Certification	Power Input
	EHG7305 Series	5-Port GbE Unmanaged ATEX Switch	5	-	ATEX EN50155 EN50121-4 12-52 VDC
	EHG7306 Series	6-Port GbE Unmanaged ATEX Switch	5	1	
	EHG7307 Series	7-Port GbE Unmanaged ATEX Switch	5	1x 100/1000Mbps SFP 1x 1000 Mbps SFP	

Network Management Utility

ATOP Network Management Utility is the best way to manage ATOP industrial managed switches. It helps to remotely configure and maintain networks in minutes.

NMU can be installed on any computer connected to the network. Simple Network Management Protocol (SNMP) is used for device management and configuration. In addition, real-time events and logs are sent to syslog servers for full awareness of network health and corresponding decision.

Main Features

- Device Discovery with Visualized Network Topology
- Device grouping
- Access credential maintenance
- Remote Device Setting
- Batch Device Setting
- Remote Firmware Upgrade, mass-update, and mass-automatic update scheduling
- Remote Device Reset
- Backup and restore configuration, mass-backup, and mass-automatic scheduling
- Configuration of SNMP traps, syslog

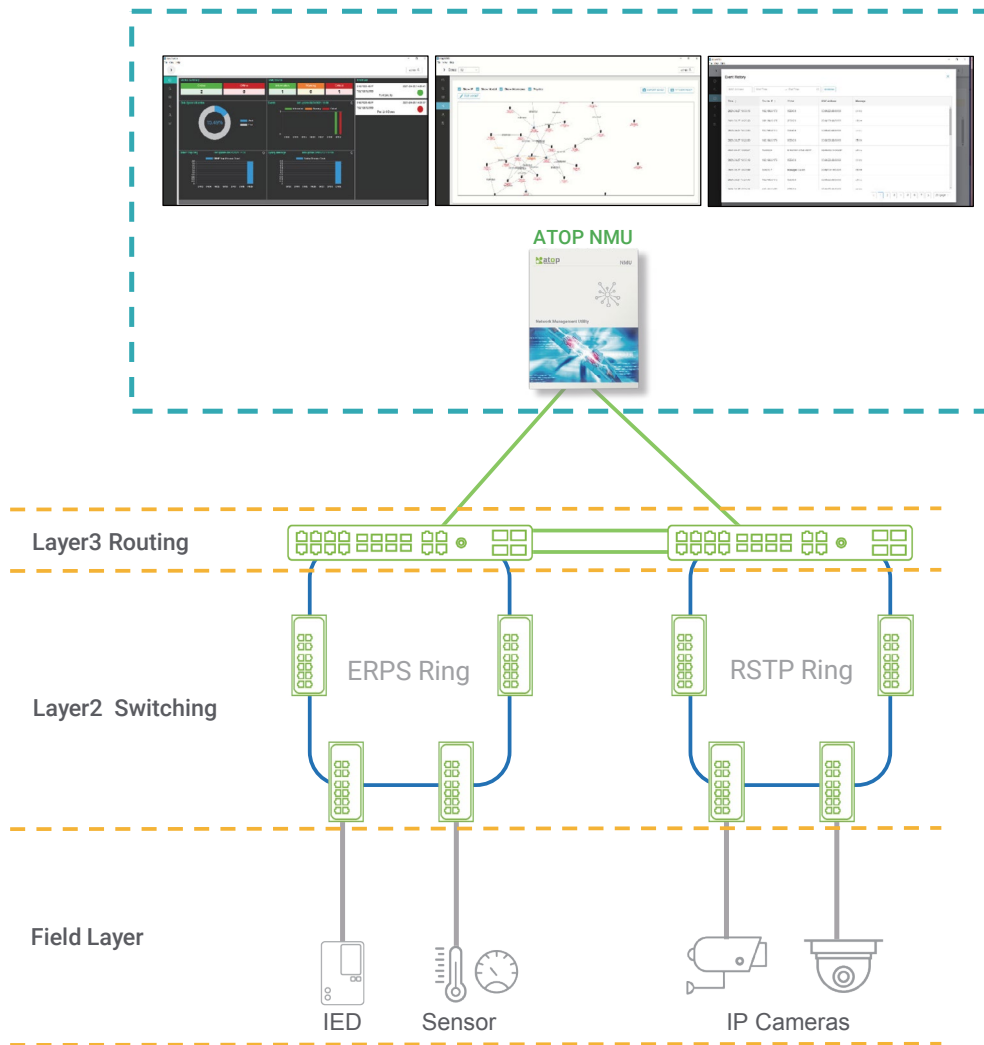

Industrial Wireless

As equipment becomes more and more interconnected, and factories and sites more and more extended in range, wireless connectivity has become a tool of growing importance to not only simplify installation and maintenance, but to also create previously unimagined possibilities for IIoT.

Securely with state-of-the-art encryption that extends connectivity beyond four walls of the building, ATOP's Industrial Wireless Access Points (AP) provide reliable, robust, rugged, and cost-effective solutions for industrial applications that require wireless connectivity.



ATOP APs (Access Points) and routers are equipped with MU-MIMO/MIMO antennas. Frequency bands IEEE 802.11 b/g/n for 2.4GHz and IEEE 802.11 a/n(ac) for 5GHz are supported. With different deployment scenarios, various operation modes are available, including AP mode, WDS Bridge mode, and AP Client mode.

For applications requiring enhanced connection speed or stability, we strive to incorporate in our wireless solutions the latest technologies such as 5G, mmWAVE, Wi-Fi Mesh, and fast roaming. Supporting features like PoE and SD slots further assist management and improve overall user experience.

Wireless communication has different cybersecurity risks as wired communications, but ATOP considers security from the start of development, mastering strict tests for security functions, abnormal traffic, stability and vulnerabilities, including malware attacks and dynamic analysis.

For use in industrial environments, ATOP APs and routers are DIN-rail mountable, industrial EMC certified, and designed to operate in temperature from -10°C to +60°C or even wider for specific models.



Industrial Access Point / IEEE 802.11n / Din-Rail Mount / Metal Housing



Model	Description	10/100/1000 Mbps RJ-45 Port	Frequency Band	2.4GHz Standard	5GHz Standard	Advanced Antenna Technologies	Operation Mode
 AW5500	IEEE 802.11 n Dual-Band Access Point	1x 10/100 /1000 Mbps RJ-45 port	2.4GHz 5GHz	IEEE 802.11 b/g/n	IEEE 802.11 a/n	MIMO	2.4GHz, 5.0GHz MIMO
AW5500C	IEEE 802.11 n Single-Band Access Point	1x 10/100 Mbps RJ-45 port	2.4GHz	IEEE 802.11 b/g/n	-	-	2.4GHz

Industrial Wireless Access Point / IEEE 802.11a/b/g/n/ac / DIN-Rail Mount / Metal Housing

Coming soon!



Model	Description	10/100/1000 Mbps RJ-45 Port	Frequency Band	2.4GHz Standard	5GHz Standard	Advanced Antenna Technologies	Operation Mode
 AW5601	IEEE 802.11 a/b/g/n/ac Dual-Band Wi-Fi Access Point with fast roaming, max throughput 867 Mbps Single PoE RJ-45 Port	1	2.4GHz 5GHz	IEEE 802.11 b/g/n	IEEE 802.11 a/n/ac	MIMO	AP Mode, Bridge Mode, AP Client Mode

5G mmWAVE Router / IEEE802.11ac / Waterproof Plastic Housing

SCN5802 is a versatile AP router that supports not only Sub-6 and LTE, but also mmWave capability. With shorter wavelengths, mmWave allows greater frequency reuse and higher density of users.

SCN5802 can convert 5G signals into Wi-Fi signals, providing a stable and high-speed network. Its compact size and industrial-grade hardware ensures flexibility and reliability in harsh or moving environments.

Coming soon!



Model	Description	10/100/1000 Mbps RJ-45 Port	10/100/1000/ 2500 Mbps RJ-45 Port	Frequency Band	5GHz Standard	Advanced Antenna Technologies	Operation Mode
 SCN5802	5G Sub-6/5G mmWave/ LTE IP67 Router with IEEE 802.11 a/n/ac	1 x LAN	1 x PoE PD LAN	5GHz for Wi-Fi n257 for mmWave	IEEE 802.11 a/n/ac	MIMO	Wi-Fi Router

Industrial Wi-Fi Mesh

In a smart factory or industrial operation, a robust, fault-free communication network is extremely important in order to weave a resilient network in indoor environments and provide a cost-effective, easy solution to ensure uninterrupted data transmission.

Many such facilities are in harsh terrains, where deploying a wired network is not possible, hence going wireless holds the key. In normal wireless topologies every end-node is connected to the centralized Access Point, so with a suddenly disabled or out of range AP, the section of the network connected to that Access Point would collapse. However, Wi-Fi Mesh is different. In the Mesh topology every node acts as an end device or a forwarding node thus minimizing network disablement. An open-ended infrastructure of nodes are wirelessly connected and rely on each other to extend a radio signal (Wi-Fi) to route, relay and proxy traffic to and from clients.

ATOP's Wi-Fi Mesh device simplifies the deployment of wireless networks in factories, warehouses or industrial facilities. The self-forming, self-healing nature ensures that the other elements of the Mesh would channel the information through a different path.

Besides Mesh, the device can still do the general functions such as standard AP or STA (client). With optional PoE power or additional Serial ports, the device is also available as a serial server / protocol gateway / Modbus gateway.





Industrial Wi-Fi Router / IEEE 802.11ac / MU-MIMO / Din-Rail Mount / Metal Housing

NEW -40°C 75°C Industrial EMC DIN MU-MIMO IP30 IEC60529

Model	Description	10/100/1000 Mbps RJ-45 Port	Frequency Band	2.4GHz Standard	5GHz Standard	Advanced Antenna Technologies	Operation Mode
	AWR5805	1x WAN 4x non-PoE LAN	2.4GHz 5GHz	IEEE 802.11 b/g/n/ac	IEEE 802.11 a/n/ac	MU-MIMO	Wi-Fi Router
	AWR5805P	1x WAN 4x PoE LAN					Router Satellite for Mesh

LTE & 5G Router / Wi-Fi / IEEE 802.11ac / MU-MIMO / Din-Rail Mount / Metal Housing

NEW 5G -40°C 75°C Industrial EMC DIN MU-MIMO IP30 IEC60529

Model	Description	10/100/1000 Mbps RJ-45 Port	Frequency Band	2.4GHz Standard	5GHz Standard	Advanced Antenna Technologies	Operation Mode
	CWR5805	1x WAN 4x non-PoE LAN	2.4GHz 5GHz	IEEE 802.11 b/g/n	IEEE 802.11 a/n/ac	MU-MIMO	Wi-Fi Router Router Satellite for Mesh
	CWR5805P	4x non-PoE LAN					
	CWG5804	1x WAN 4x non-PoE LAN	2.4GHz 5GHz	IEEE 802.11 b/g/n	IEEE 802.11 a/n/ac	MU-MIMO	Wi-Fi Router Router Satellite for Mesh
	CWG5804P	4x PoE LAN					

Interoperability



ATOP has media converters from entry level to advanced level, shifting networks between copper and various Fiber optics, including SFP, single/multi-mode SC/ST connectors.

All ATOP media converters come with redundant power inputs. The converters are able to operate in temperatures from -20°C to +70°C, or even from -40°C for dedicated models.



Ethernet-to-Fiber / Auto Speed Negotiation / Din-Rail Mount / Metal Housing



Model	Description	10/100 Mbps RJ-45 Port	10/100/1000 Mbps RJ-45 Port	Fiber Port	Max. Signal Transmission Distance
	EF23-1-1Fm-SC-2	Converter for FE to Multi-mode SC-Fiber, with Max. Transmission Distance 2 km	1	1 (multi-mode)	2 km
	EF23-1-1Fs-SC-30	Converter for FE to Single-mode SC-Fiber, with Max. Transmission Distance 30 km	1	1 (single-mode)	30 km
	EF24L-1G-1Fm-SC-550M	Converter for GbE to Multi-mode SC-Fiber, with Max. Transmission Distance 550 m	-	1 (multi-mode)	550 m
	EF24L-1G-1Fs-SC-10	Converter for GbE to Single-mode SC-Fiber, with Max. Transmission Distance 10 km	-	1 (single-mode)	10 km
	EF24L-1G-1SFP	Converter for GbE to SFP-Fiber	-	1 (SFP slot)	-

Serial-to-Fiber / Din-Rail Mount / Metal Housing



Model	Description	RS-232 RS-485 RS-422 TB5	Fiber Port	Max. Signal Transmission Distance	
	SF63-TB-DB-1Fm-SC-2	Converter for Serial to Multi-mode SC-Fiber, with Max. Transmission Distance 2 km	1	1x Multi-mode SC Connector	2 km
	SF63-TB-DB-1Fs-SC-30	Converter for Serial to Single-mode SC-Fiber, with Max. Transmission Distance 30 km	1	1x Single-mode SC Connector	30 km
	SF63-TB-DB-1Fm-ST-2	Converter for Serial to Multi-mode ST-Fiber, with Max. Transmission Distance 2 km	1	1x Multi-mode ST Connector	2 km
	SF63-TB-DB-1Fs-ST-30	Converter for Serial to Single-mode ST-Fiber, with Max. Transmission Distance 30 km	1	1x Single-mode ST Connector	30 km

Plug-On / RS-232-to-RS485/422 / Compact Size



Model	Description	RS-232	RS422/485	Isolation Voltage	Power Connector
	SS100	DB9	TB-6	-	TB-2
	SS100-SiS-R	DB9	TB-6	3000 VDC at RS232	TB-2
	SS100-J	DB9	TB-6	-	DC-Jack

Industrial IoT Remote I/O

The ATOP IO5202 series is a cost-effective solution for integrating existing applications into an IIoT framework. Offering plug-and-play simplicity, it supports numerous protocols and uses intelligent processing and publishing features to poll, log, or even automatically push data when I/O statuses change. Also, data can be pushed to connect and interact with a public or private cloud servers.

Modbus/TCP/RTU/ASCII / MQTT Support / High-EMC / DIN-Rail Mount / Metal Housing



Model	RS-232 RS-485 RS-422 TB5	RS-232 RS-485 RS-422 DB9	10/100 Mbps RJ-45 port	Digital Inputs	Digital Outputs	DIO Selected by jumper	Relay Outputs	Analog Inputs	Analog Outputs	
	IO5202-DB-16-0-0-0	-	1	2	8	8	-	-	-	
	IO5202-TB-16-0-0-0	1	-	2	8	8	-	-	-	
	IO5202-DB-0-0-8-0	-	1	2	-	-	-	-	8	
	IO5202-TB-0-0-8-0	1	-	2	-	-	-	-	8	
	IO5202-DB-6-2-4-0	-	1	2	6	-	-	2	4	
	IO5202-TB-6-2-4-0	1	-	2	6	-	-	2	4	
	IO5202-DB-8-4-0-0	-	1	2	-	-	8	4	-	
	IO5202-TB-8-4-0-0	1	-	2	-	-	8	4	-	
	IO5202-DB-0-0-4-4	-	1	2	-	-	-	-	4	4
	IO5202-TB-0-0-4-4	1	-	2	-	-	-	-	4	4

Serial Device Server

ATOP's serial-to-Ethernet device servers allow easy connection between RS-232/422/485 legacy devices to Ethernet through wired or wireless means. These devices are specifically designed to allow industrial devices to be accessible from the local network or the Internet. ATOP has serial device servers from entry-level to industrial-level, supporting 1x to 16x serial. With wall-mount, DIN-rail mount, or rackmount housing, ATOP serial device servers can be easily deployed and help to integrate the legacy devices to a modern network. ATOP industrial serial device servers comply with industrial network requirements, such as IEC 61850 and EN 50155.

ATOP serial device servers' are programmable with SDKs on Linux platforms. With help from the provided Programming Guide, users can develop programs for specific applications. [Contact your account manager for more information.](#)

Entry-Level Serial Device Server

Specially designed for automation fields, ATOP's entry-level serial device servers provide 1x or 2x RS-232/RS-422/RS-485 port(s). They are suitable for simple and less demanding applications. Protected by rugged metal case with wall or DIN-rail mount, these serial device servers are available with a DB9 or TB5 connector with 2 kV magnetic isolation. Specific models are High-EMC certified.



Entry-Level / Wall Mount / Metal Housing



Model	Description	RS-232 RS-485 RS-422 TB5	RS-232 RS-485 RS-422 DB9	10/100 Mbps RJ-45 Port	Operating Temperature
	SE5201C-DB	-	1	1	-40°C to +70°C
	SE5201C-TB	1	-	1	-40°C to +70°C

High-EMC / Wall Mount / Metal Housing



Model	RS-232 RS-485 RS-422 TB5	RS-232 RS-485 RS- 422 DB9	10/100 Mbps RJ-45 Port	100 Mbps SFP Slot	Notes	
	SE5201-DB	-	1	1		
	SE5201-TB	1	-	1		
	SE5202-DB	-	2	1	-	
	SE5202-TB	2	-	1	-	
	SE5202-SIS	2	-	1	-	2.5 kV isolation
	SE5202-SFP-DB	-	2	-	1	
	SE5202-SFP-TB	2	-	-	1	

Wireless/Cellular Serial Device Server

ATOP wireless/cellular serial device server is a rugged, reliable, and affordable solution for conversion between serial and Ethernet signals. The serial device servers are equipped with 1x or 2x available ports, and either with terminal block or DB9 connector. Featuring with wireless or cellular connectivity, ATOP wireless/cellular serial device server can provide Wi-Fi in places difficult to deploy AP or Wi-Fi routers. IEEE 802.11 a/b/g/n standards are supported for wireless technology, and with dual MIMO antennas. For cellular connectivity, 3G, 4G, and HSPA are available.

Industrial Serial Device Server / Wi-Fi / IEEE 802.11n / Din-Rail Mount



Model		RS-232 RS-485 RS-422 TB5	RS-232 RS-485 RS-422 DB9	10/100 Mbps RJ-45 Port	Notes
	SW5501C	1	1	1	Equipped with WPS button
	SW5502C-TB	-	2	1	Equipped with WPS button
	SW5502C	2	-	1	Equipped with WPS button

High-EMC / Industrial Serial Device Server / Wi-Fi / IEEE 802.11n / Din-Rail Mount



Model		RS-232 RS-485 RS-422 TB5	RS-232 RS-485 RS-422 DB9	10/100/1000 Mbps RJ-45 Port	Notes
	SW5501	-	1	1	
	SW5501-TB	1	-	1	
	SW5501-SiS	1	-	1	2 kV isolation
	SW5502	-	2	1	
	SW5502-TB	2	-	1	
	SW5502-SiS	2	-	1	2 kV isolation

4G & LTE / Serial Gateway / Din-Rail Mount

The new SE5201B IoT gateway is a super-low power consumption LTE gateway. In addition to high EMC protection, wide-temperature operation, and rugged metal housing, SE5201B series has a configurable power management mechanism to reduce device power consumption. It is suitable for various operations, especially in power-challenged environments.

Coming soon!



Model	Cellular	RS-232 RS-485 TB9	RS-232 RS-485 DB9	10/100 Mbps RJ-45 Port	SIM slot	Notes
	SE5201B-C1-DB-EU	LTE Cat.1 (EU)	-	1	-	-
	SE5201B-C1-DB-US	LTE Cat.1 (US)	-	1	-	-
	SE5201B-C1-DB-EU-GPS	LTE Cat.1 (EU)	-	1	2/2	GPS
	SE5201B-C1-DB-EU-GPS	LTE Cat.1 (US)	-	1	2/2	GPS
	SE5201B-C1-TB-EU	LTE Cat.1 (EU)	1	-	-	-
	SE5201B-C1-TB-US	LTE Cat.1 (US)	-	-	2/2	-
	SE5201B-C1-TB-EU-GPS	LTE Cat.1 (EU)	-	-	2/2	GPS
	SE5201B-C1-TB-US-GPS	LTE Cat.1 (US)	-	-	-	GPS
	SE5201B-M1-DB	LTE Cat.M1/NB-IoT	-	-	-	-
	SE5201B-M1-TB	LTE Cat.M1/NB-IoT	-	-	-	-

4G & LTE / VPN Router / Serial Gateway / Digital I/O / Din-Rail Mount



Model	RS-232 RS-485 TB14	RS-232 RS-485 DB9	10/100/1000 Mbps RJ-45 Port	Digital Inputs/ Digital Outputs	Notes	
	SE5901B-D3G	-	1	1	-	
	SE5901B-4G	-	1	1	-	
	SE5901B-IO-4G	1+1*	-	1	2/2	-
	SE5901B-IO-4G-GPS	1+1*	-	1	2/2	GPS
	SE5901B-4G-B	-	1	1	-	Battery function
	SE5901B-IO-4G-B	1+1*	-	1	2/2	Battery function
	SE5901B-IO-4G-GPS-B	1+1*	-	1	2/2	GPS / Battery function

* 1x TB14 sw-selectable RS-485 / RS-232 and 1x RS-232.

** New features include Port-Forwarding, NAT, IPsec, OpenVPN, PPTP and SMS management

Advanced Serial Device Server

To satisfy requirements for rigorous industrial automation, ATOP provides serial device servers featuring with high- EMC capabilities for harsh environments, and built in with faster CPU to reduce the processing time.

For specific models, gigabit Ethernet is provided with/without PoE to reduce the need for extra power supply.

The advanced serial server devices are able to operate in the temperature from -20°C to +70°C. Some dedicated models can even operate between -20°C to +85°C.

Advanced Industrial Serial Device Servers, DIN-Rail Mount



Model		RS232-RS485-RS422 TB5	RS-232 RS-485 RS-422 DB9	10/100 Mbps RJ-45 Port
	SE5901-DB	-	1	2
	SE5901-TB	1	-	2

* New features include IPsec, OpenVPN, PPTP and RSTP redundancy.

Serial Device Server / Gigabit / DIN-Rail Mount



Model	RS-232 RS-485 RS-422 TB5	RS-232 RS-485 RS-422 DB9	10/100 Mbps RJ-45 Port	Gbps	Notes	
	SE5904D-DB	-	4	2	-	
	SE5904D-TB	4	-	2	-	
	SE5904D-SIS	4	-	2	-	3 kV isolation
	SE5904D-G-DB-SFP	-	4	-	2	
	SE5904D-G-TB-SFP	4	-	-	2	
	SE5904D-G-Sis-SFP	4	-	-	2	3 kV isolation

Serial Device Server / Fast Ethernet / Rack Mount



Model	RS-232 RS-485 RS-422 RJ-45	RS-232 RJ-45	10/100 Mbps RJ-45 Port	Notes
SE5908-DC	8	-	2	
SE5908-SiS-DC	-	8	2	2.5 kV isolation
SE5916-DC	16	-	2	
SE5916-SiS-DC	-	8	2	2.5 kV isolation
SE5908-EU	8	-	2	
SE5908-US	8	-	2	
SE5916-EU	16	-	2	
SE5916-US	16	-	2	
SE5908-SiS-EU	-	8	2	2.5 kV isolation
SE5908-SiS-US	-	8	2	2.5 kV isolation
SE5916-SiS-EU	-	16	2	2.5 kV isolation
SE5916-SiS-US	-	16	2	2.5 kV isolation



Serial Console Server

Console servers manage large numbers of devices through serial ports. With smart port forwarding function, it helps simplify network topologies and wiring. Besides process equipment, connect it to switch com ports to enable remote management even when the Ethernet connection is faulty. ATOP's VSE59xx series come with 8 to 48 ports in a compact 1U rackmount, suitable for any scenario.

Coming soon!



Model	Serial RJ45 Port	10/100/1000 Mbps RJ-45 port	100/1000 SFP	Power	Operating Temperature
VSE5908	8	2	2	100-240 VAC	5°C to 70°C
VSE5916	16				
VSE5932	32				
VSE5948	48				



IEC61850-3 Substation-Specific Serial Device Server

ATOP's Substation serial servers feature: 8 to 16 x Serial ports (RS-232/RS-485/RS-422) with or without isolation; 6 x Ethernet ports with RJ45 or SFP connector; Wide -40°C to +85°C temperature range and are enclosed in a rugged IP30-rated rack-mount housing. Available in two power options: redundant 24–48VDC input or redundant 100–330VDC / 100–240VAC, with additional relay outputs available.

IEC61850-3 Certified Substation Serial Device Server



Model	RS-232 RS-485 RS-422 TB5	RS-232 RS-485 RS-422 DB9	10/100 Mbps RJ-45 Port	100 Mbps SFP Slot	Notes
SE5908A **	-	8	6	-	
SE5908A-TB **	8	-	6	-	
SE5908A-SIS **	8 *	-	6	-	3 kV isolation
SE5908A-6SFP **	-	8	-	6	
SE5908A-6SFP-TB **	8	-	-	6	
SE5908A-6SFP-SIS **	8 *	-	-	6	3 kV isolation
SE5916A **	-	16	6	-	
SE5916A-TB **	16	-	6	-	
SE5916A-SIS **	16 *	-	6	-	3 kV isolation
SE5916A-6SFP **	-	16	-	6	
SE5916A-6SFP-TB **	16	-	-	6	
SE5916A-6SFP-SIS **	16 *	-	-	6	3kV isolation



* The SiS (3kV isolated) version supports 8x or 16x RS-422/ RS-485
 ** All versions are available in 24-48 VDC or 100-370 VDC/100-240 VAC power input (add -HV to model name)
 *** New features include IPsec, OpenVPN, PPTP and RSTP redundancy.

EN50155 Railway Specific Serial Device Server

ATOP's railway serial servers are equipped with 2x RS-232/RS-485/RS-422 serial ports and 1x M12 Ethernet connector. The railway serial servers are enclosed in a waterproof IP68 housing, providing 15 kV ESD protection on serial signals to protect costly and sensitive equipments.

EN50155 Railway Waterproof Serial Device Server



Model	Description	RS232-RS485-RS422 M12	10/100 M12 Ports	Additional features	
	SE8502-M12	Ethernet-to-Serial Device Server with waterproof and EN50155 certification	2	1	
	SE8502-Sis-M12	Ethernet-to-Serial Device Server with waterproof, EN50155 certification, and 2 kV isolation	2	1	2 kV isolation

SDK-Included Serial Device Servers

ATOP SDK includes tools, libraries, relevant documentation, code samples, processes, and guides, allowing developers to create software applications on a specified platform. For functional requirements or services that are not available on standard products (for example in IoT applications) or with communication, security, or data filter needs, SDKs enable users to create proprietary apps easily and incorporate strong ATOP solutions into tailored systems.

Model	Description	4G cat 4.	RS232 RS422 RS485	10/100 Mbps RJ-45 Port	IEC 61850-3
SE5901 SDK	Ethernet to Serial Industrial Embedded Computer	-	1	2	-
SE5901B SDK	4G LTE Cellular to Ethernet and Serial Secure Embedded Computer	✓	1	1	-
SE5904D SDK	4-Port Industrial Ethernet to Serial Embedded Computer	-	4	2	-
SE5908 SDK	8-Port Industrial Serial to Ethernet Embedded Computer	-	8	2	-
SE5916 SDK	16-Port Industrial Serial to Ethernet Embedded Computer	-	16	2	-
SE5908A SDK	8-Port Industrial Serial to Ethernet Embedded Computer	-	8	2	✓
SE5916A SDK	16-Port Industrial Serial to Ethernet Embedded Computer	-	16	2	✓







Protocol and Modbus Gateway

Protocol Gateway

With industrial IoT, devices of all levels, origins, and generations may communicate with each other either directly or indirectly. Protocol gateways provide translation between those that were designed for different protocols, or with legacy equipment. This allows more flexible installation, less renewal costs, and overall cost efficiency.

ATOP protocol gateways support multiple industrial protocols including Modbus, DNP3, IEC 61850, IEC 60870-5-101/3/4. Selected models can operate in temperatures as wide as -40°C to +85°C, and are IEC61850-3 certified. User-friendly eNode Designer ensures that operations from deployment and configuration to management is easy throughout the process.











Model	RS232 RS422 RS485	10/100 Mbps RJ-45 Port	4G cat 4.	IEC 61850-3	Operating temperature
 PG5901	1	2	-	-	-40°C to +85°C
 PG5901B	1	1	✓	-	-40°C to +70°C
 PG5904D	4	2	-	-	-40°C to +85°C
 PG5908	8	2	-	-	-20°C to +70°C
 PG5916	16	2	-	-	-20°C to +70°C
 PG5908A	8	2	-	✓	-40°C to +85°C
 PG5916A	16	2	-	✓	-40°C to +85°C

Modbus Gateway

Based on ATOP's industrial-grade hardware, our Modbus gateways offer seamless conversion between Ethernet-based Modbus TCP and serial-based Modbus RTU/ASCII for demanding applications such as Industry 4.0 and Smart Grids. Advanced features protect data over the Internet with secure IPsec VPN or OpenVPN tunnels, with powerful CPU providing up to 37.9Mbps* software-assisted AES encryption. Added values include digital I/O accessible via dedicated Modbus Registers and 15 seconds of back-up power.



Model	RS232 RS422 RS485	10/100 Mbps RJ-45 Port	4G cat 4.	IEC 61850-3	Operating temperature
 MB5201	1	1	-	-	-40°C to +70°C
 MB5202	2	1	-	-	-40°C to +70°C
 MB5901	1	2	-	-	-40°C to +85°C
 MB5901B	1	1	✓	-	-40°C to +70°C
 MB5904D	4	2	-	-	-40°C to +85°C
 MB5908	8	2	-	-	-20°C to +70°C
 MB5916	16	2	-	-	-20°C to +70°C
 MB5908A	8	2	-	✓	-40°C to +85°C
 MB5916A	16	2	-	✓	-40°C to +85°C

OFFICAL WEBSITE



LITERATURE LIBRARY



ATOP Technologies | by BlackBear TechHive

2F, No. 146, Sec. 1, Dongxing Rd., Zhubei City, Hsinchu County, Taiwan

☎ +886-3-550-8137

☎ +886-3-550-8131

✉ info@atop.com.tw